

vektron installation manual

technics & dimensions

name	reference	WxL	fixture	colour	system power (W)
raft 1844x2444mm	VK9181X1-90XX-A	1844x2444	aplis 60	white	53
	VK9181X2-90XX-A	1844x2444	aplis 60	black	53
	VK9181X1	1844x2444	-	white	-
	VK9181X2	1844x2444	-	black	-
raft 1844x3644mm	VK9183X1-90XX-A	1844x3644	aplis 60	white	80
	VK9183X2-90XX-A	1844x3644	aplis 60	black	80
	VK9183X1	1844x3644	-	white	-
	VK9183X2	1844x3644	-	black	-

VK91811X-90XX-A

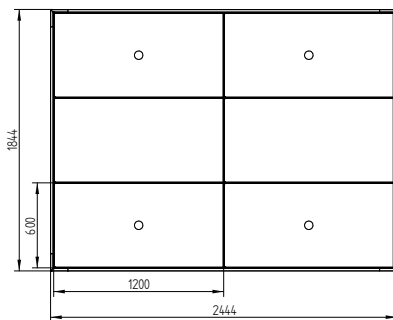

VK91831X-90XX-A

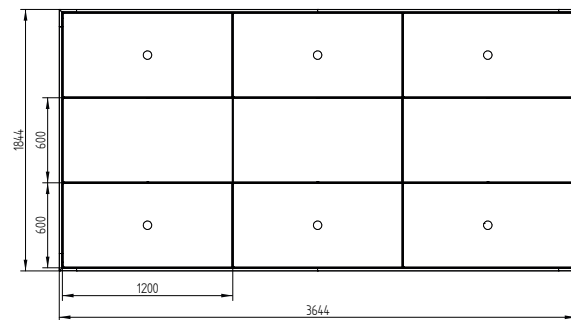

VK91812X-90XX-A

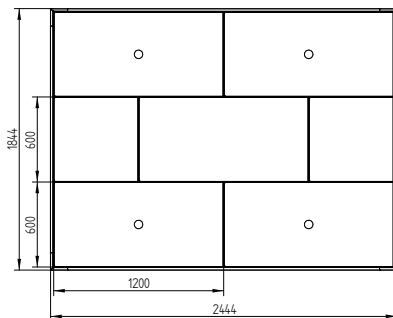

VK91832X-90XX-A

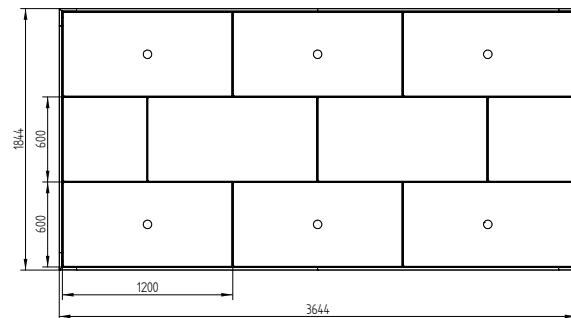

VK91813X-90XX-A

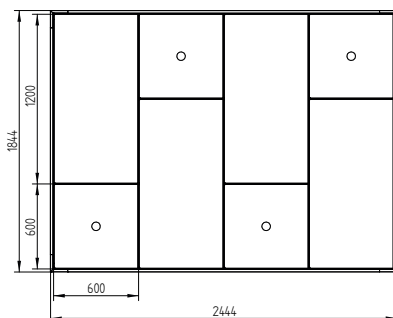

VK91833X-90XX-A

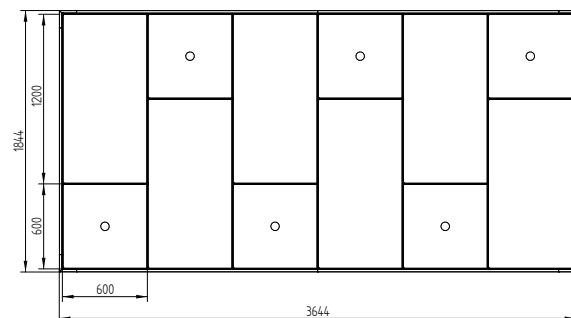

1824

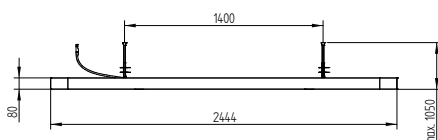

1836

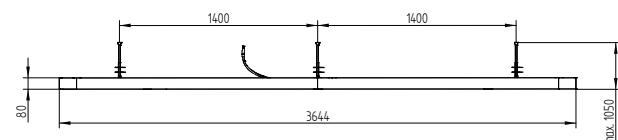

shipment details

1824

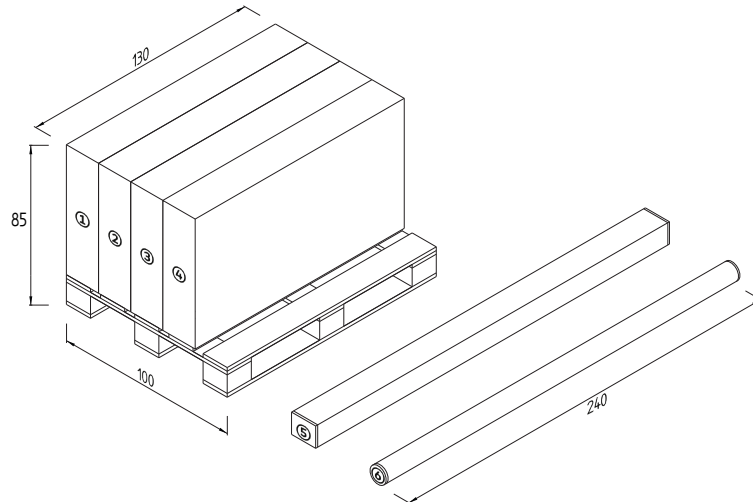

1. mineral wool
2. ceiling tiles
3. service pack / elektrical components
4. mineral wool
5. edge finishing components
6. subconstruction components

 40 kg

1836

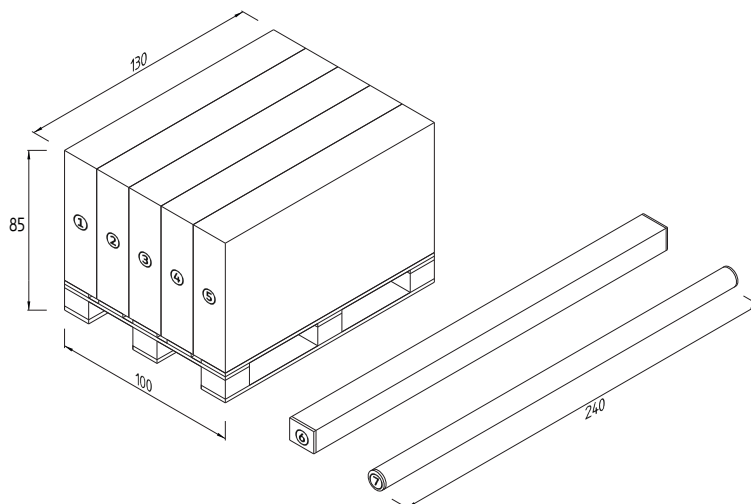

1. mineral wool
2. tiles
3. service pack / electrical components
4. tiles
5. mineral wool
6. edge finishing components
7. subconstruction components

 65 kg

subconstruction components

VK770033

clip-in carrier



VK770164

t-connection



VK770187

nonius hanger black lower part



VK770034

clip-in carrier mounting corner



VK770187

nonius hanger black upper part 94cm



VK770123

cross connector H0



VK710114

nonius locking clip



VK770125

end cross connector H0



VK770163

clip-in splice



tiles

VKX790417528

clip-in tile 1200 x 600mm, full perfo R1, aplis 60

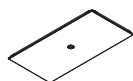

VKX760417301

clip-in tile 600 x 600mm, full perfo R1, aplis 60



VKX790413E119

clip-in tile 1200 x 600mm, full perfo R1



VKX60413380

clip-in tile 600 x 600mm, full perfo R1



electrical components

CS907763-9030-FL

aplis 60 downlight, flood



VK770203

extension cable, 1m, 2-pole connector (male-female) with strain relief, low voltage



CS706096

gearbox, 350 mA, DALI, 60W, 3m cable



CS706966

gearbox, 350 mA, DALI, 39W, 3m cable



mineral wool

VS760403

sealed mineral wool 600x600x35 - 35kg/m³



edge finishing components

VK7600xx

edge cover 80 straight



VK760094

edge cover 80 corner piece 122 x 122mm



VK76009x

edge cover 80 straight splice



KR7000005155

cross.rec.tapping screw st3,5x9,5



1. electrical connection

connect the **female** connector to the mains cable

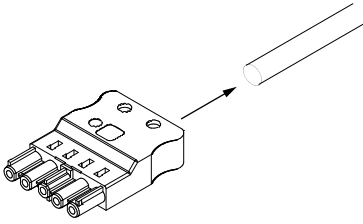

please make sure the main voltage is disconnected before proceeding!

on/off



DALI

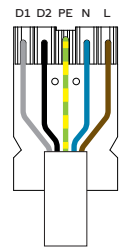

2. drilling holes

drill holes for mounting the nonius hangers, for more info on hole spacing for your specific raft, see **annex 1**, subconstruction details
pay attention to the direction of the primary carrier!

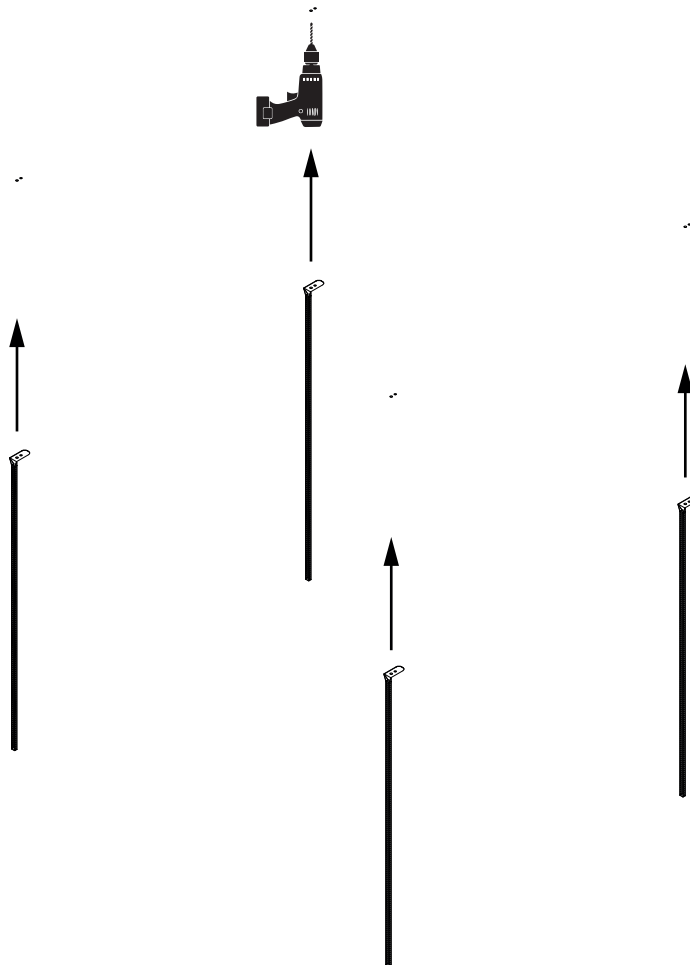

vektron installation manual

3. install nonius hangers & primary carriers

fasten upper part nonius hanger to ceiling with 2 screws, not included, specific for the architectural situation

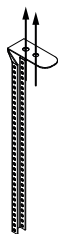

position lower part nonius hanger in primary clip-in carrier and rotate 90°

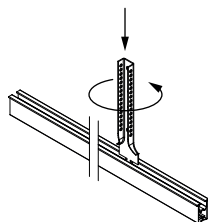

position upper part in lower part adjust height according to ceiling

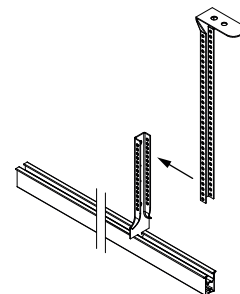

fixate with 2 locking clips

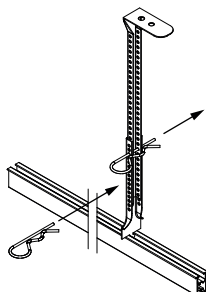

for lengths greater than 3m, use clip-in splice to link two carriers

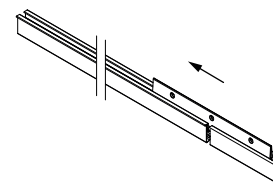
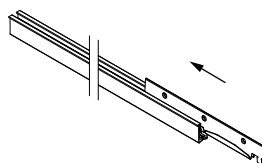

4. install secondary carriers

insert cross connector H0 and end cross connector H0 on secondary carriers

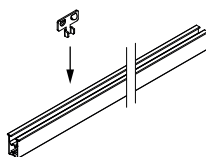

twist to lock cross connectors in place

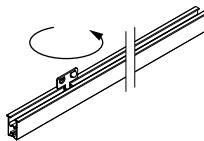

click cross connectors in primary carriers

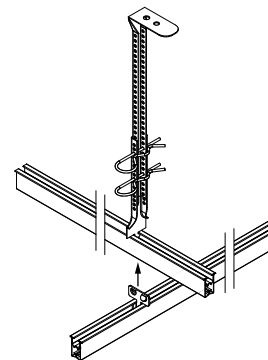

use t-connection for fixation of perpendicular secondary carriers

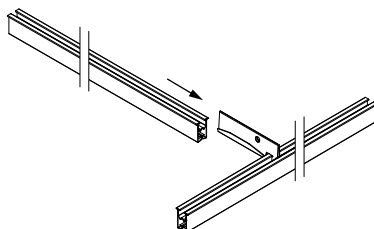

use mounting corners in corners of secondary carriers

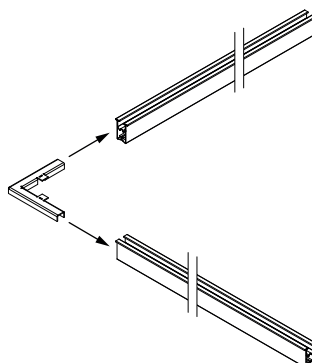

for lengths greater than 3m, use clip-in splice to link two carriers

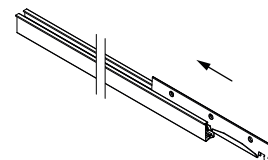

5. install lighting fixture

see installation manual of lighting fixture to install lighting on the tile

connect the extension cable to the fixture, make sure not to cover the fixtures with mineral wool!

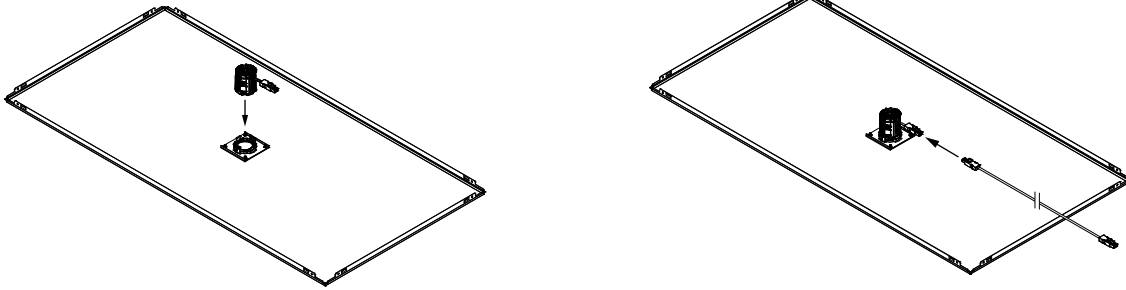

6. install lighting tiles

clip lighting tiles in the secondary carriers according to your raft type, see page 1 for more info

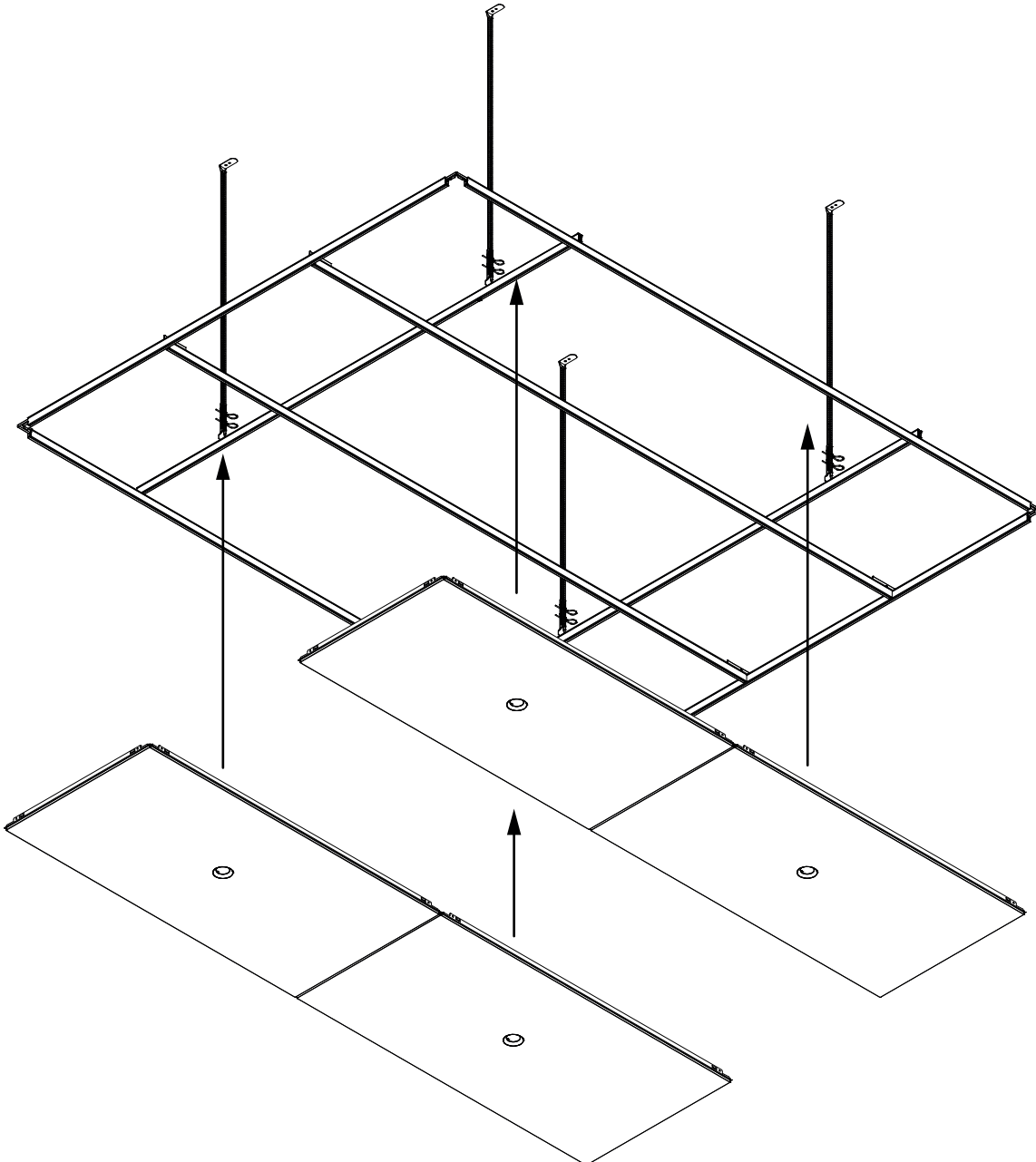

7. install gearbox

mount gearbox on clip-in carrier
fixate with 2x cross connector H0

- 1 connect extension cable from fixture to gearbox
- 2 connect gearbox connector to mains connector

important note:
every output of the gearbox must
have a connector wich is a lighting
fixture or a connector loop!

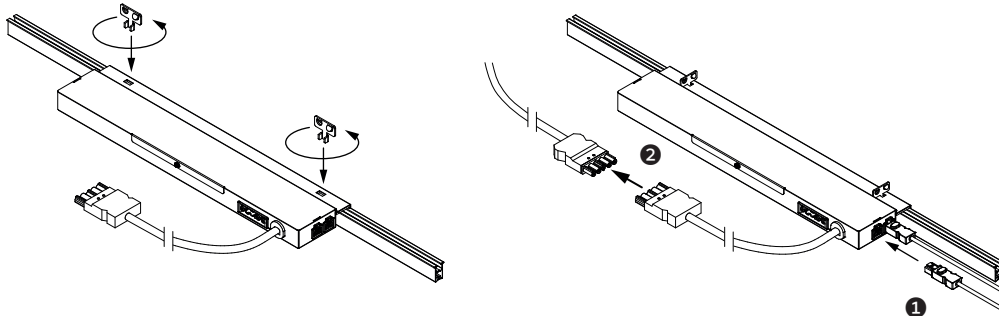

8. install tiles

clip the remaining tiles in the secondary carriers

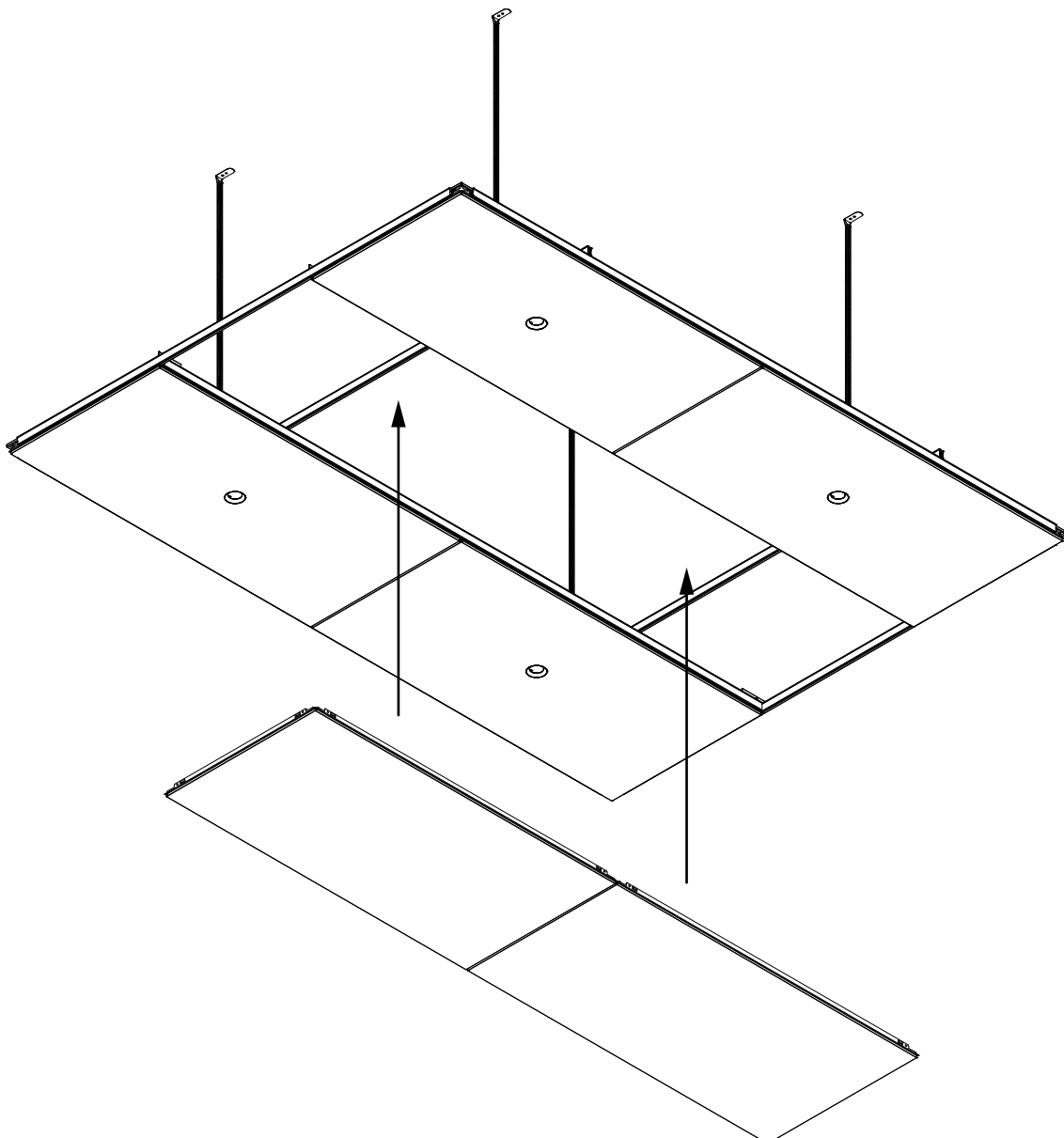

9. install edge covers

clip edge covers in secondary carriers and slide splices in edge covers, then click corners in secondary carriers

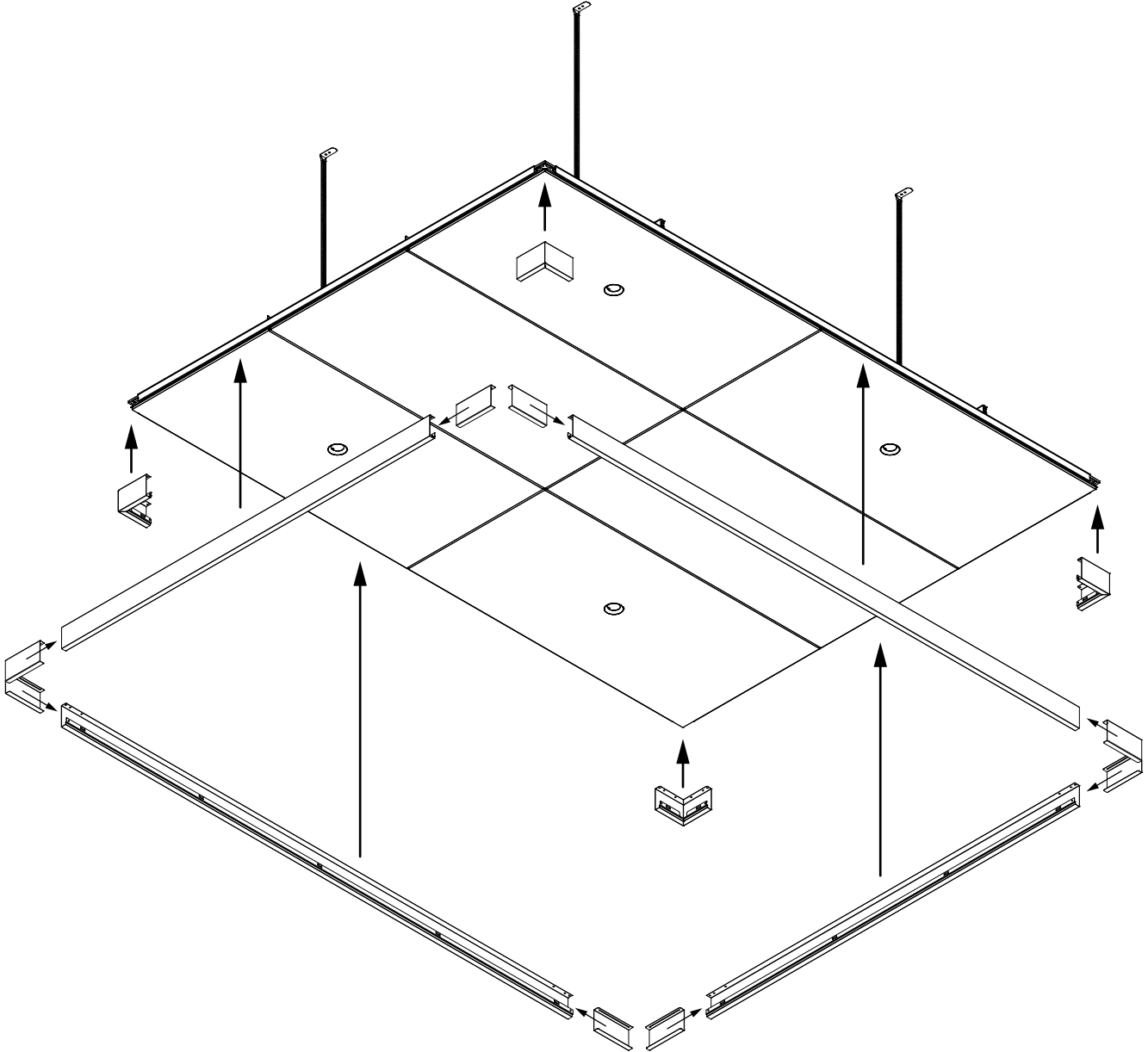

10. fasten corners

position splices partly in the corner and partly in the edge cover

use 2-4 screws for every splice to fixate the edge covers

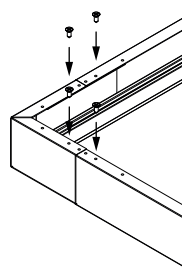
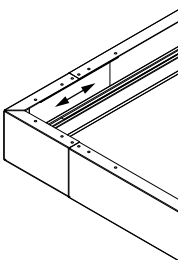

vektron installation manual

ANNEX 1: SUBCONSTRUCTION DETAILS

VK91811X, VK91812X

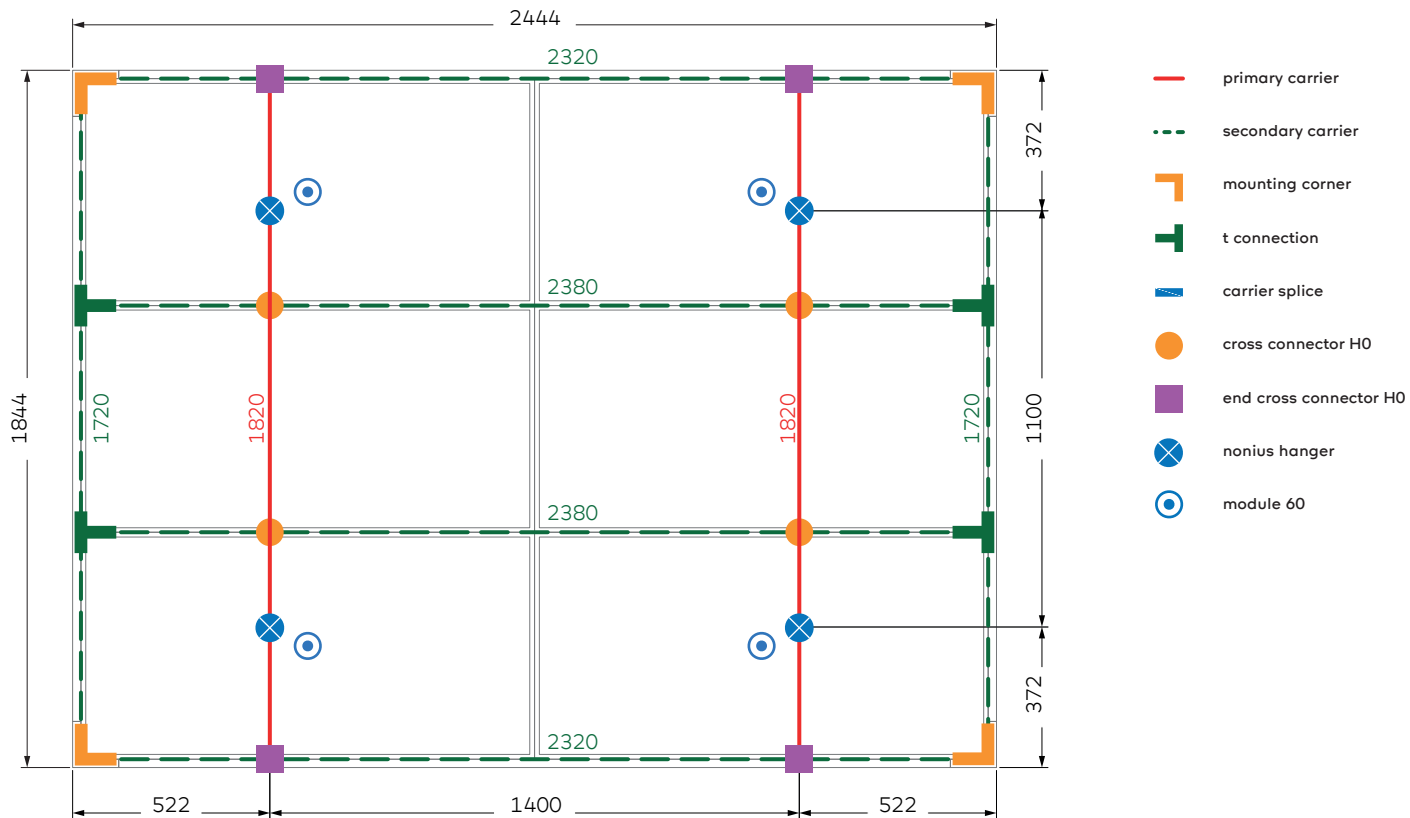

VK91813X

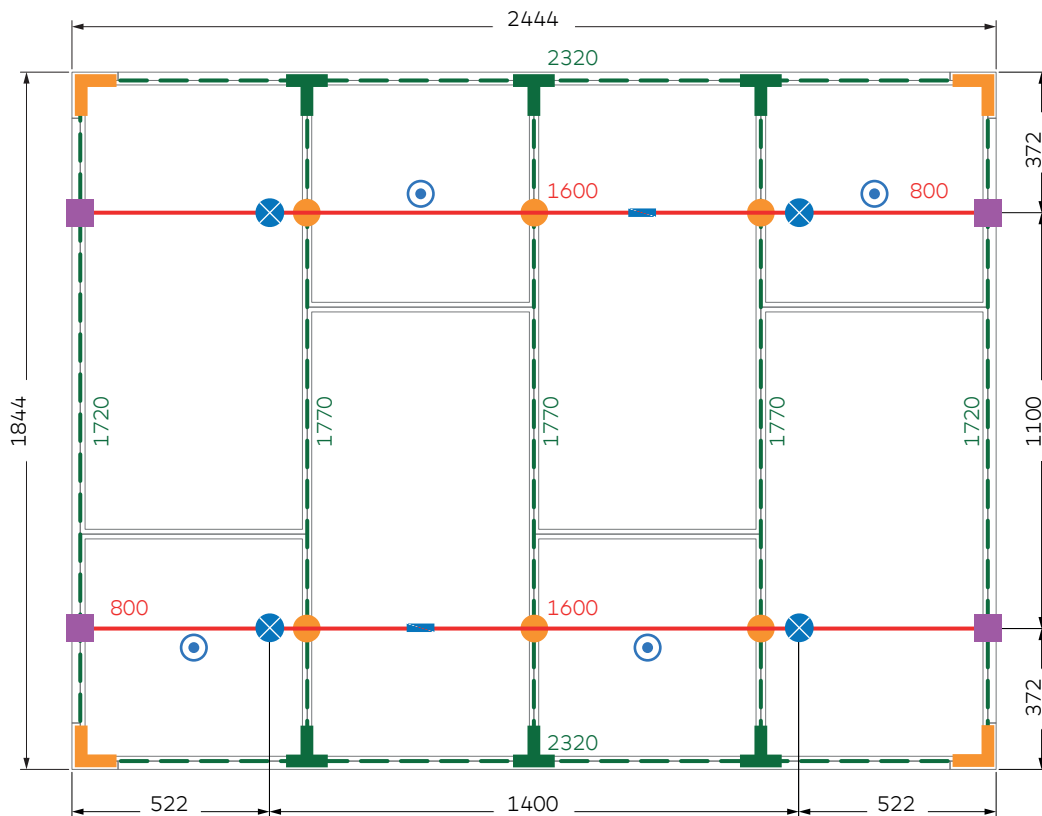

VK91831X, VK91832X

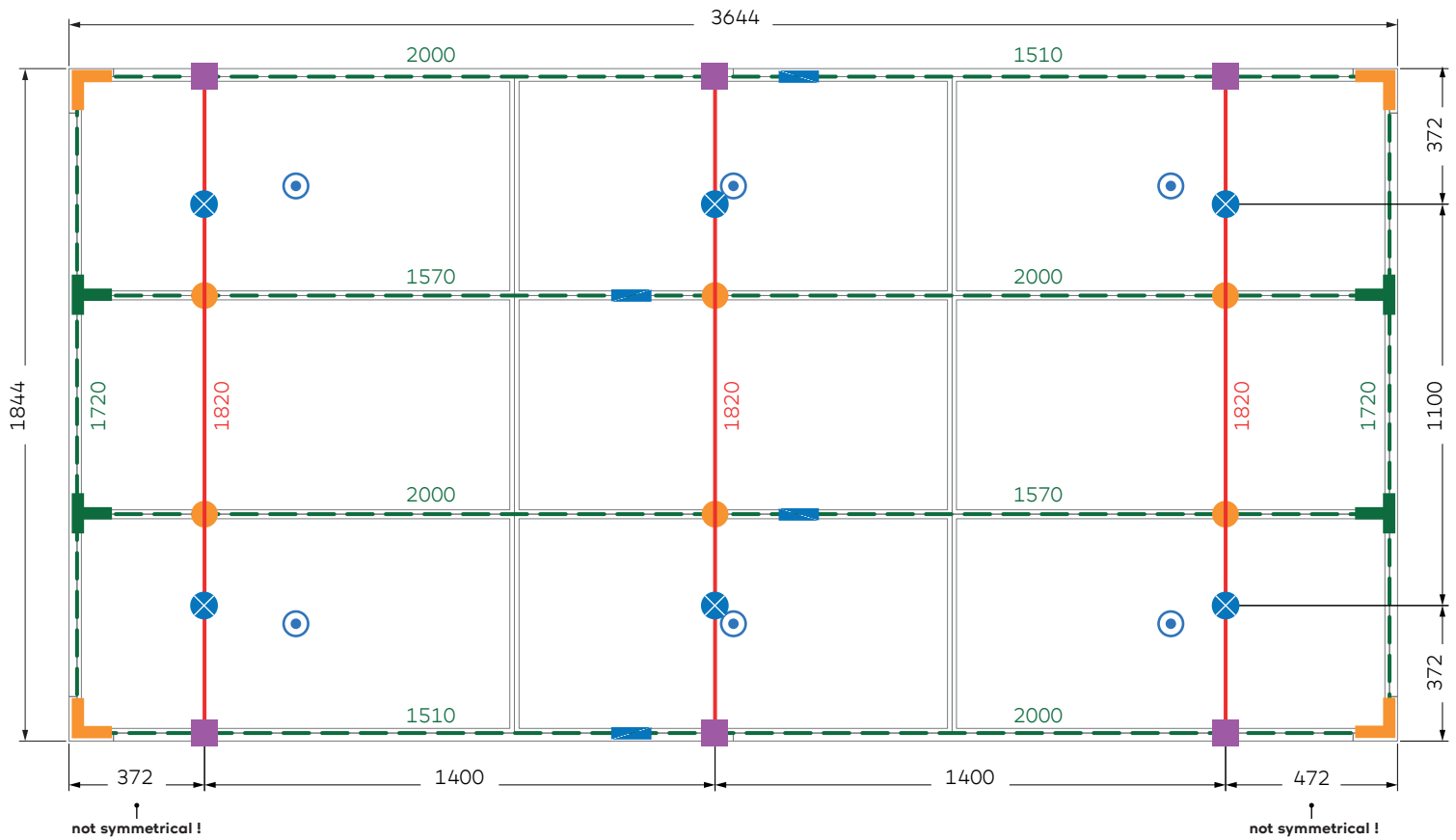

VK91833X

