

kreon plug & play





## Easy to order, easy to install

kreon tools of light introduces a selection of standard plug & play products. A selection of unique architectural tools of light, gear included, surface mounted, easy to order and to install. These valuable additions facilitate a multitude of additional options in professional light planning for both, contract, and domestic application.





luminaires	ceiling	9
	pendant	35
	wall	45
	floor	51
	table	53
	outdoor	57
gearboxes	overview	59

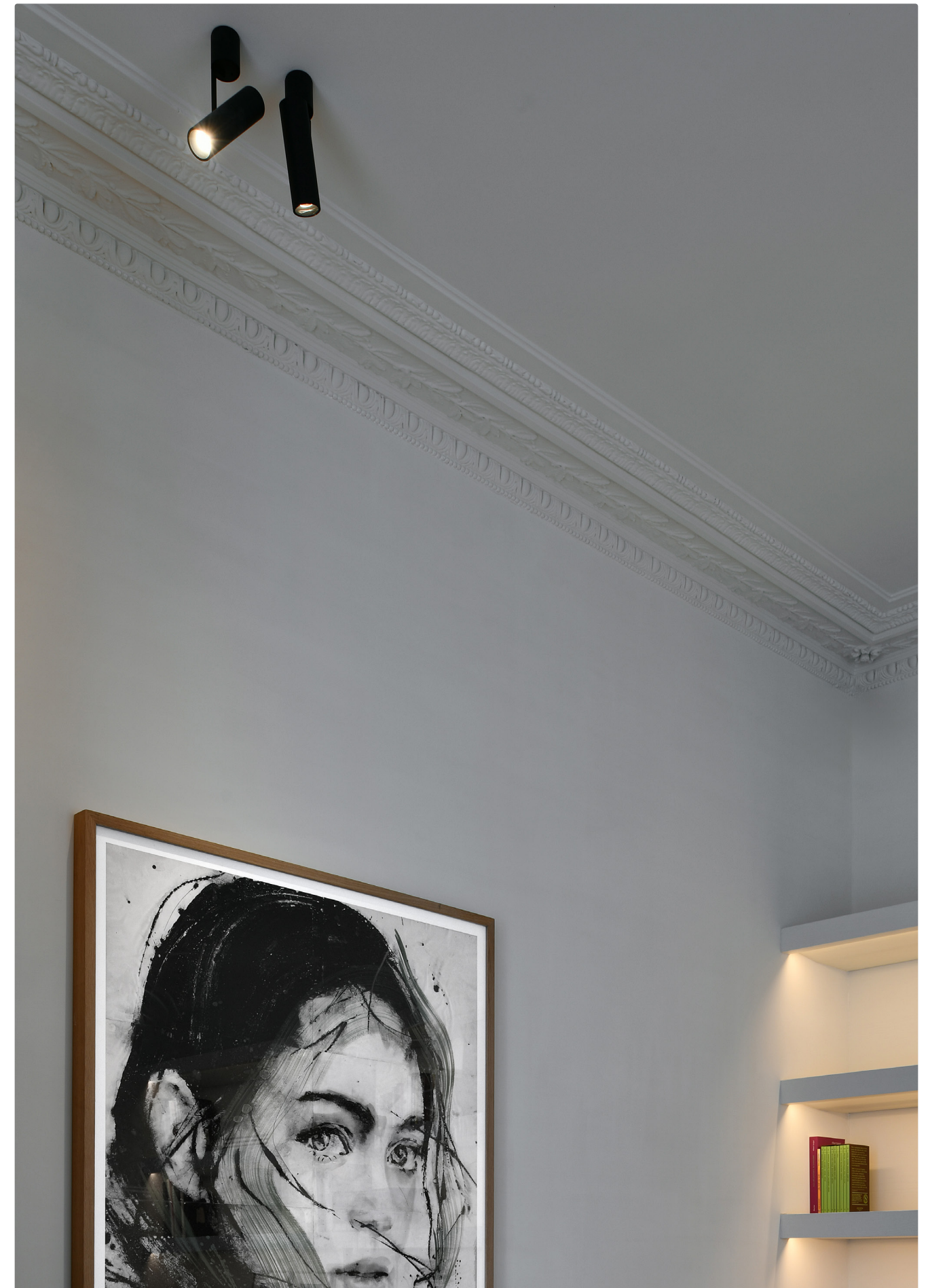

# kreon product overview

## ceiling luminaires

prologe  
9

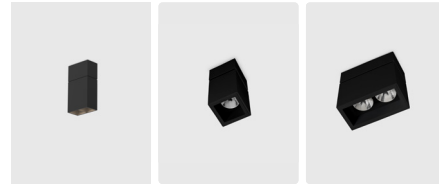

nuit  
17



holon  
19



erubo  
25



esprit  
27



fuga  
29

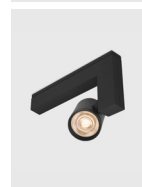

cadre  
31

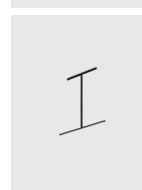

## pendant luminaires

holon  
35



oran  
39

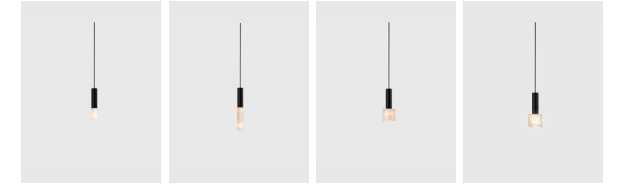

esprit  
43

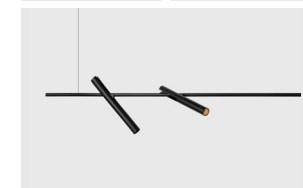



wall luminaires

onn wall  
45

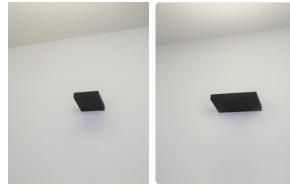

oran  
47

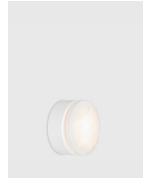

kagi  
49



floor luminaires

esprit  
51



desk luminaires

esprit  
53



oran object  
55



outdoor luminaires

wabi  
57

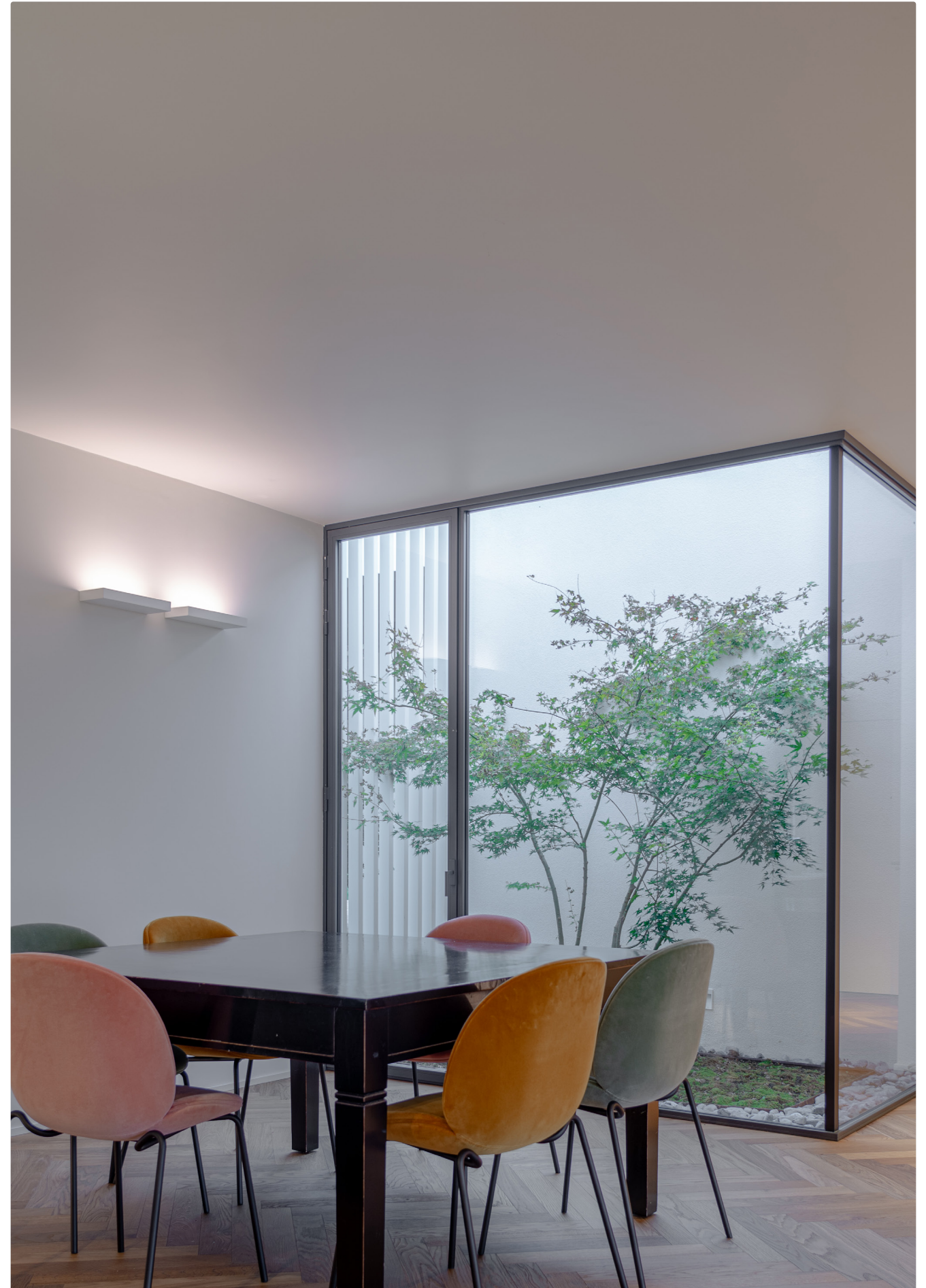
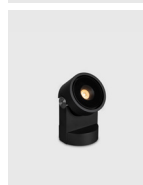



# kreon prologe 40

Project private residence  
Location Milan, Italy

Architect S.Festini, Voltaire sas  
Photographer Serge Brison

kreon prologe 40 is characterised by its compact form, hosts a double deepset invisible LED source and can be fitted with professional darklight optics with lumen packages up to 920lm. Finished in black for a dramatic contrast or pure white to disappear in the surrounding architecture.

kreon prologe 40 wants to create functional light through the discreet presence of simple architectural volumes in a compact surface mounted box

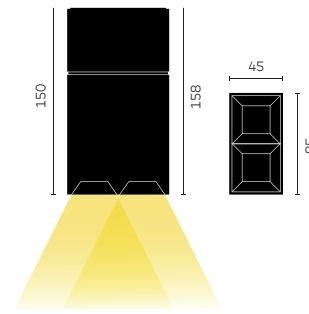

## general information

application	surface-mounted luminaire for ceilings
IP classification	40
input voltage	230V
electric gear	included
louvre	always black for DL/WDL
illuminant (per lamphead)	
output SP-FL-WFL	912lm
output DL-WDL	621lm

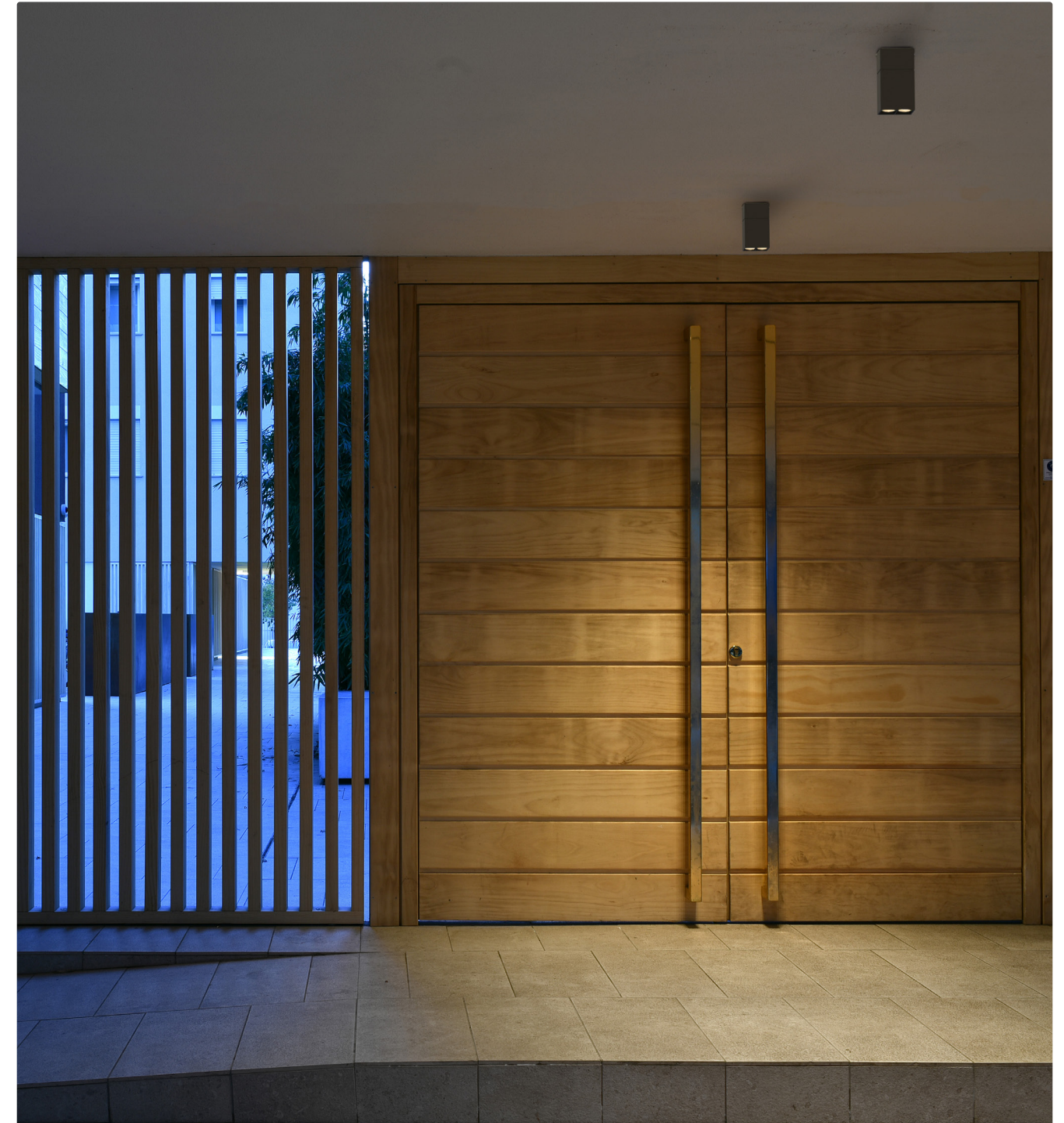

## Ordering Codes

KR_____	___-	__-	—
basic code	CCT-CRI	optic	dim protocol
KR967341 - prologe 40 double, white KR967342 - prologe 40 double, black	9027 9030	SP - spot 20° FL - flood 30° WFL - wide flood 40° DL - dark light 40° WDL - wide dark light 76°	SW - onn off PD - phase dim
Ordering example: KR967341-9027-SP-SW			

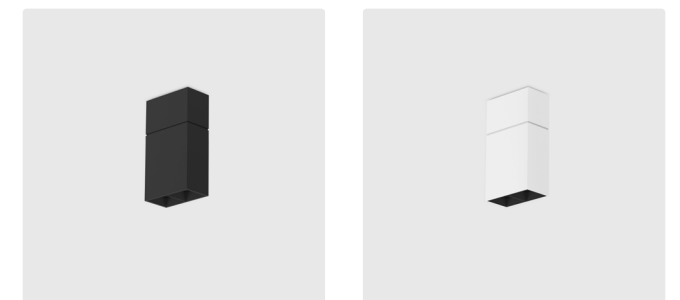



kreon prologe 80 is a range of surface mounted cubic downlights characterised by its compact form and deep set LED position. kreon prologe 80 comes in a single and a double version to suit spacial requirements, providing a discreet yet functional solution to general or accent lighting within architecture. Finished in black for a dramatic ceiling contrast or pure white for a more harmonious integration.

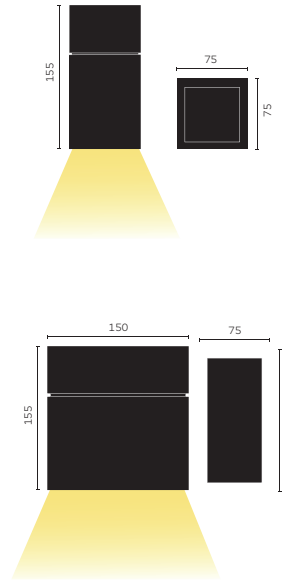

general information		
application	surface-mounted luminaire for ceilings	
IP classification	40	
input voltage	230V	
electric gear	included	
illuminant (per lamphead)		
output	480lm	

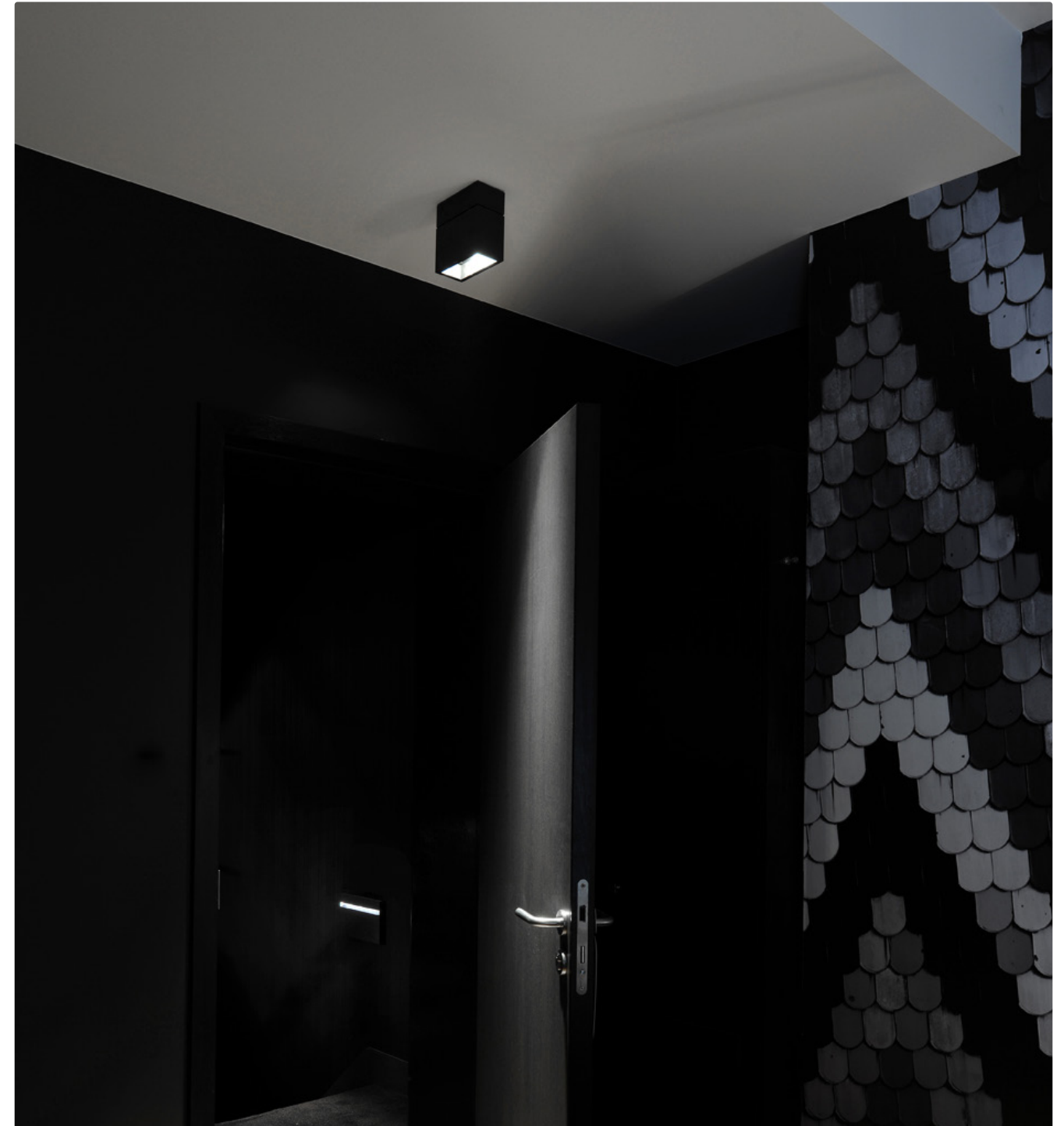

#### Ordering Codes

KR_____	___-	—
basic code	CCT-CRI	dim protocol
KR967131 - prologe 80 single, white KR967132 - prologe 80 single, black	9027 9030	SW - on off
KR967231 - prologe 80 double, white KR967232 - prologe 80 double, black		
Ordering example: KR967131-9027-SW		

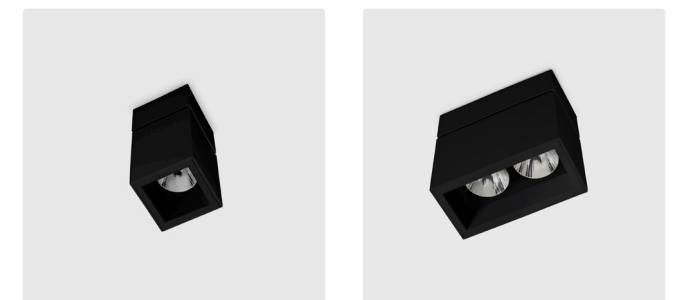

# kreon prologe 80 GU10

kreon prologe 80 is a range of surface mounted cubic downlights characterised by its compact form and deep set light source position. kreon prologe 80 comes in a single and a double version to suit spacial requirements, providing a discreet yet functional solution to general or accent lighting within architecture. Finished in black for a dramatic ceiling contrast or pure white for a more harmonious integration.

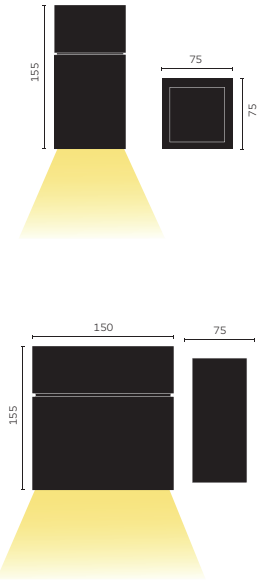

general information	
application	surface-mounted luminaire for ceilings
IP classification	40
input voltage	230V
electric gear	included
illuminant (per lamphead)	
output wattage	according to lamp spec. max. 20W

## Ordering Codes

KR_____
basic code
KR968131 - prologe 80 GU10 single, white KR968132 - prologe 80 GU10 single, black KR968231 - prologe 80 GU10 double, white KR968232 - prologe 80 GU10 double, black
Ordering example: KR968131 + KR460246

## Required Accessory

KR_____
basic code
KR460246 - PAR16 LED 9W 36° 2700K CRI95 KR460246 - PAR16 LED 9W 36° 3000K CRI95
Ordering example: KR763591

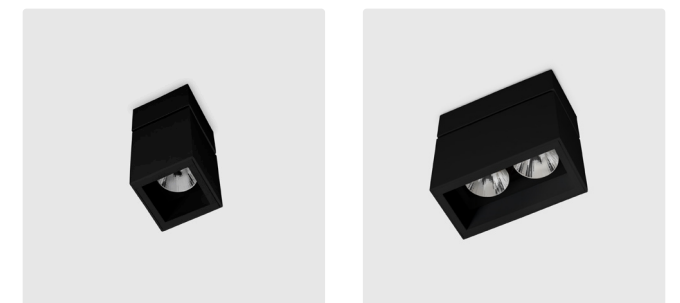



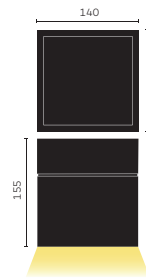

general information

application	surface-mounted luminaire for ceilings
IP classification	40
input voltage	230V
electric gear	included

illuminant (per lamphead)

output SP	890lm
output FL	755lm
output WFL	790lm



Ordering Codes

KR____-	___-	__-	—
basic code	CCT-CRI	optic	dim protocol
KR988651 - prologe 145 single, white KR988652 - prologe 145 single, black KR988751 - prologe 145 double, white KR988752 - prologe 145 double, black	9027 9030	SP - spot 14° FL - flood 30° WFL - wide flood 38°	SW - onn off VD - phase dim DD - dali dim
Ordering example: KR988651-9027-SP-SW			

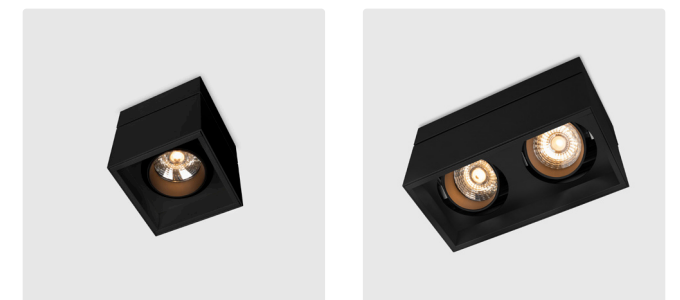

kreon nuit is an elementary designed beam that can be used as a massive line to bring graphical elements into architecture. The advanced LED system requires a slim gap of just 10mm to unfold a variety of beam angles. Its basic form draws minimal attention and can easily be used in combination with other kreon tools of light, creating an artistic yet responsible use of light sources.

The standard preconfigured lengths bring glare free accent lighting. The ideal kreon tools of light for residential, high end office and edgy hospitality projects.

## general information

application	surface-mounted luminaire for ceilings
IP classification	20
input voltage	230V
electric gear	included

## illuminant

output 1x5	585lm
output 2x5	2x585lm

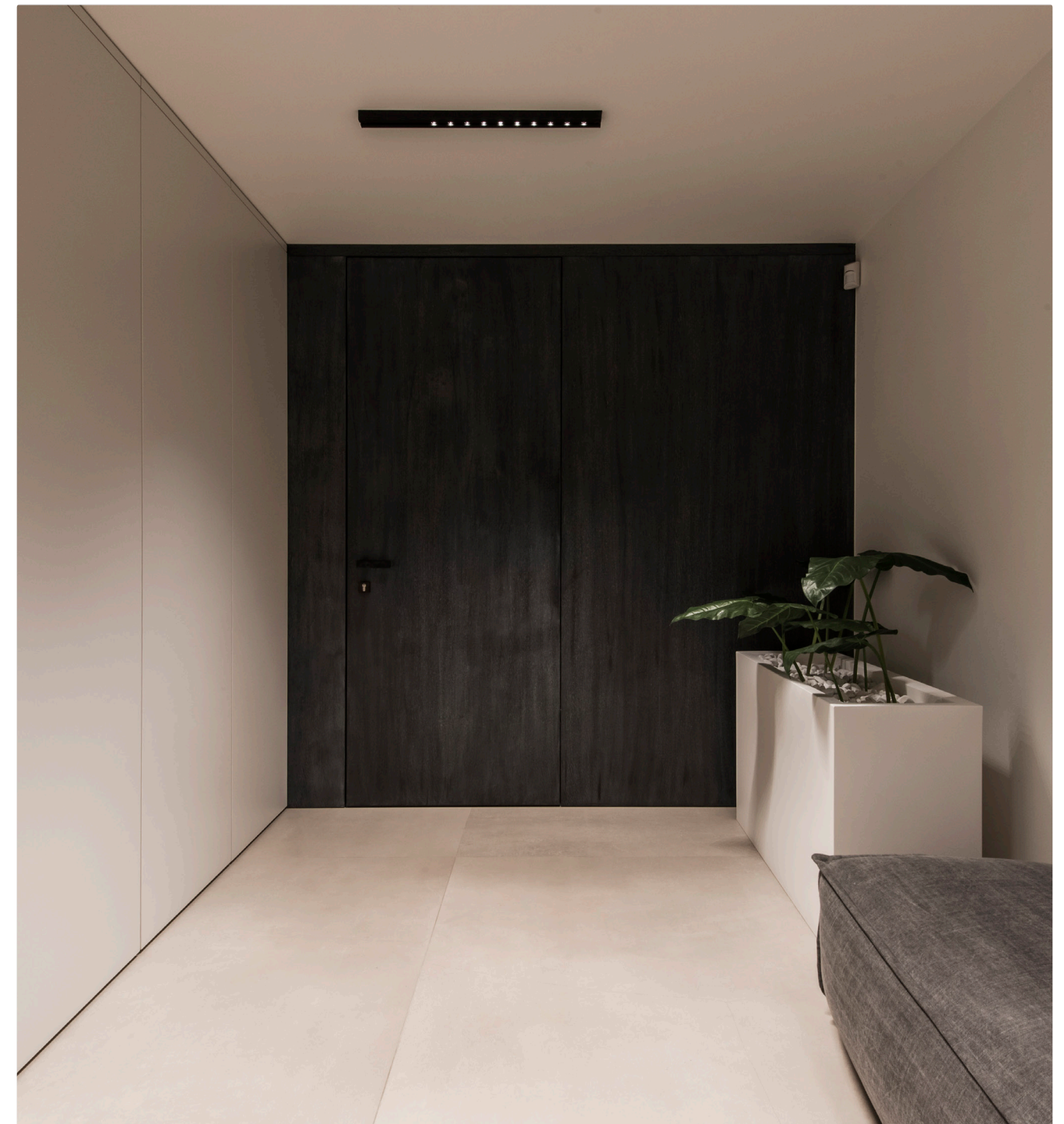
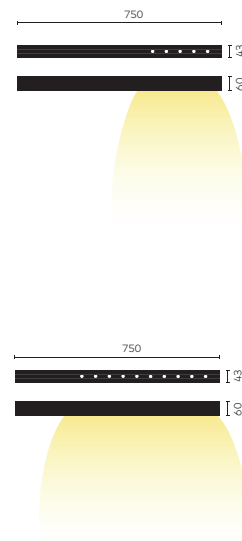

## Ordering Codes

KR____-	___-	___-	___
basic code	CCT-CRI	optic	dim protocol
KR953511 - nuit 1x5, white	9027	SP - spot 12°	DD - dali dim
KR953512 - nuit 1x5, black	9030	FL - flood 29°	PD - phase dim
KR953515 - nuit 1x5, black-white	9040	WFL - wide flood 40°	VD - 1-10V
KR953521 - nuit 2x5, white		OV - oval 13°+36°	
KR953522 - nuit 2x5, black			
KR953525 - nuit 2x5, black-white			
Ordering example: KR953511-9027-SP-DD			





# kreon holon 40 gearbox

Project private residence  
Location The Netherlands

Architect Lumio  
Photographer Serge Brison

kreon holon 40 gearbox are surface mounted luminaires with one or two spot lights and integrated gear. Like all kreon holon 40 luminaires, the lamp heads can be rotated 360° and tilted up to 90°, and come with multiple reflector options. Among the available dimming options are Casambi and DALI dimming.

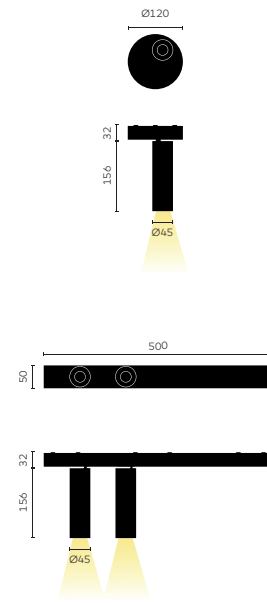

general information	
application	surface-mounted luminaire for ceilings
IP classification	40
input voltage	230V
electric gear + gearbox	included
louvre	always black for DL/WDL
illuminant (per lamphead)	
output SP-FL-WFL	558lm
output DL-WDL	417lm

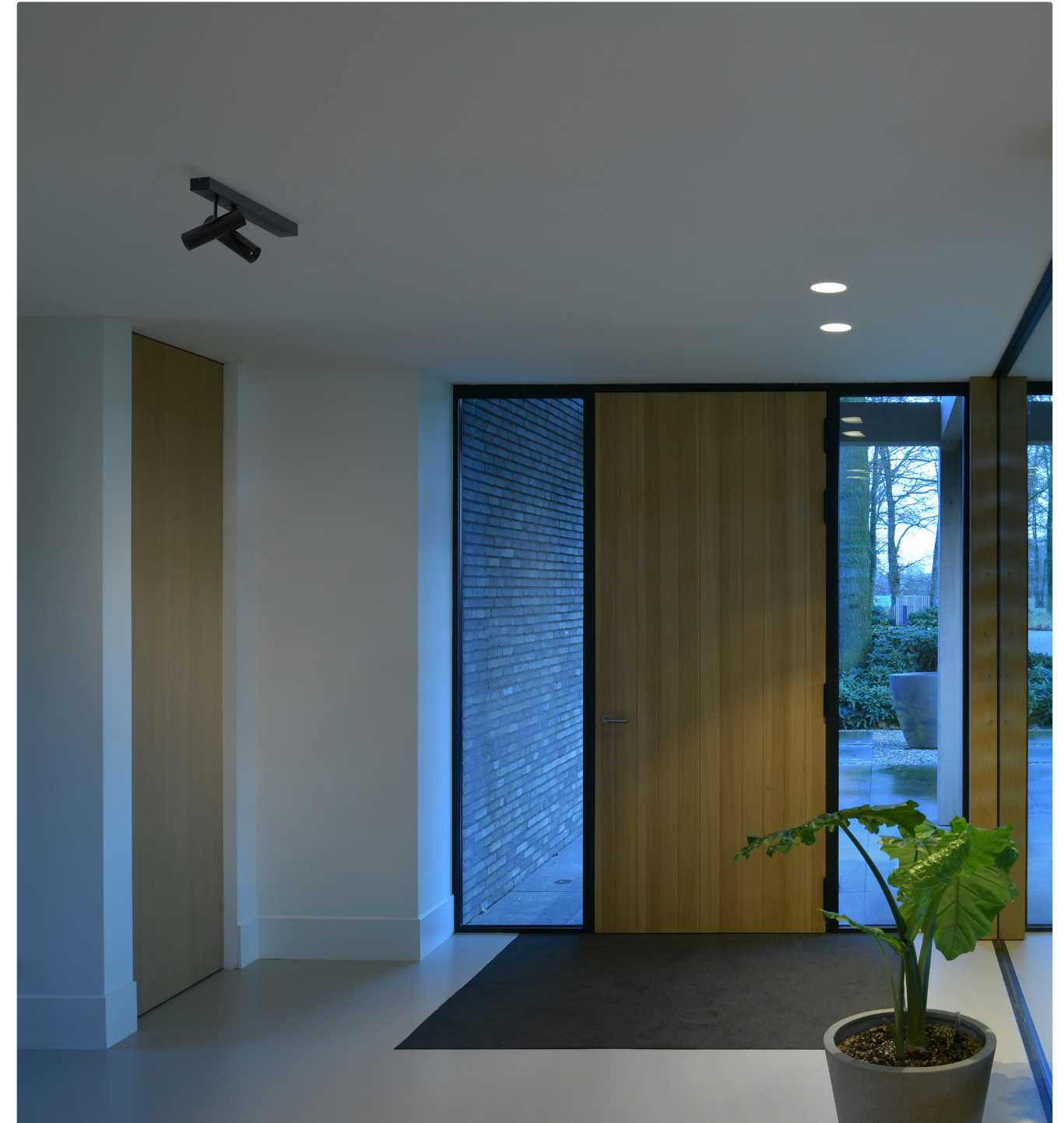

## Ordering Codes

KR_____	___-	___-	___
basic code	CCT-CRI	optic	dim protocol
KR962501 - holon 40 directional single, white KR962502 - holon 40 directional single, black KR962511 - holon 40 directional double, white KR962512 - holon 40 directional double, black	9027 9030	SP - spot 20° FL - flood 30° WFL - wide flood 40° DL - dark light 38° WDL - wide dark light 76°	PD - phase dim DD - dali dim (only available with holon 40 double) VD - 1-10V (only available with holon 40 double) CD - casambi (only available with holon 40 double)
Ordering example: KR962501-9027-SP-PD			

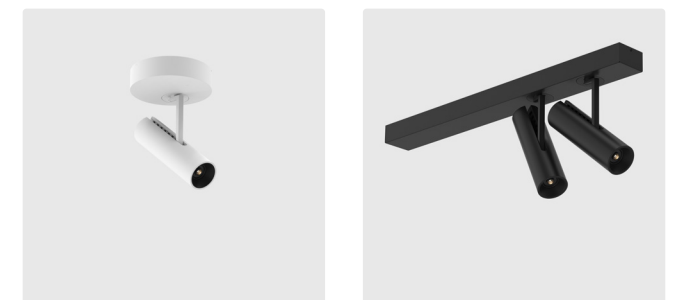

kreon holon 60 directional is a surface mounted spotlight with a rotational adjustment of 360° and an angular adjustment of 90°, which, when combined with the choice of superspot, spot, flood and wide flood reflector, provides a truly versatile accent lighting tool.

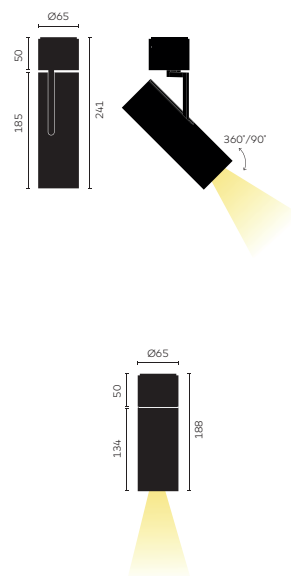

#### general information

application	surface-mounted luminaire for ceilings
IP classification	40
input voltage	230V
electric gear	included

#### illuminant

output CRI 90+	up to 1211lm
output CRI 95	up to 1090lm



#### Ordering Codes

KR_____	___	___	___
basic code	CCT-CRI	optic	dim protocol
KR962161 - holon 60 dir., deep recessed louvre, white	9027	SSP - superspot 18°	DD - dali
KR962162 - holon 60 dir., deep recessed louvre, black	9030	SP - spot 34°	SW - on/off
KR962165 - holon 60 dir., deep recessed louvre, white/black	9040	FL - flood 54°	
KR962461 - holon 60 directional, low louvre, white	9527	WFL - wide flood 69° (only with low louvre)	
KR962462 - holon 60 directional, low louvre, black	9530		
KR962861 - holon 60 fixed, low louvre, white	9540		
KR962862 - holon 60 fixed, low louvre black			

Ordering example: KR962161-9027-SP-DD

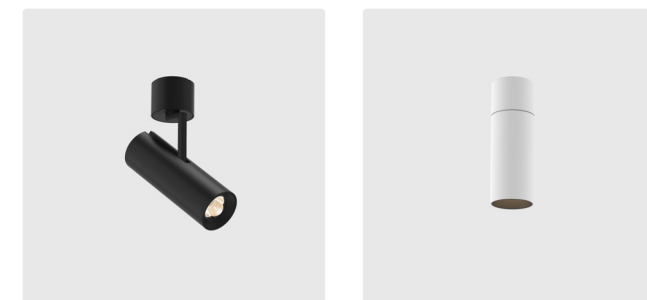



kreon holon 80 directional is a surface mounted spotlight with a rotational adjustment of 360° and an angular adjustment of 90°, which, when combined with the choice of spot, flood and wide flood TIR reflector, provides a truly versatile accent lighting tool.

kreon holon 80 fixed is the perfect solution for general lighting and features a flood beam mirror reflector set above the black or white internal louvre, optimised to create pools of light on horizontal surfaces or dramatic scalloping effects on verticals.

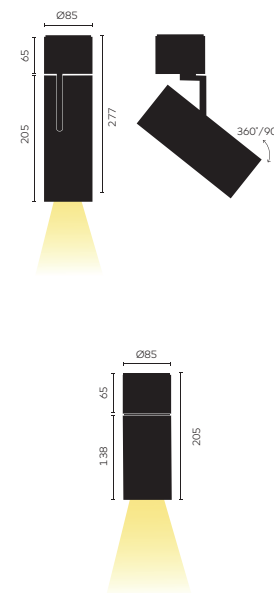

#### general information

application	surface-mounted luminaire for ceilings
IP classification	40
input voltage	230V
electric gear	included

#### illuminant

output CRI 90+	1641lm
output CRI 95+	1127lm



#### Ordering Codes

KR____-	___-	___-	__
basic code	CCT-CRI	optic	dim protocol
KR962021 - holon 80 directional, white KR962022 - holon 80 directional, black	9027 9030 9040 9527 9530 9540	FL - flood 30° WFL - wide flood 38°	DD - dali dim SW - on/off
Ordering example: KR962221-9027-SP-DD			



kreon erubo is a range of architectural spotlights characterised by its simple geometric forms that contain LED light sources and electronic dimmable drivers.

kreon erubo is available in a range of outputs and colour temperatures, providing an excellent solution for display lighting in residential projects, shops or galleries.

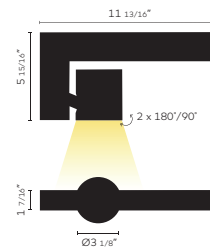

general information		
application	surface-mounted spotlight	
IP classification	40	
input voltage	230V	
electric gear	included	
protection class	1	
illuminant		
output phase-dim, CRI90	1595lm	
output phase-dim, CRI95	1276lm	
output 1-10V DALI, CRI90	1420m	
output 1-10V DALI, CRI95	1276lm	

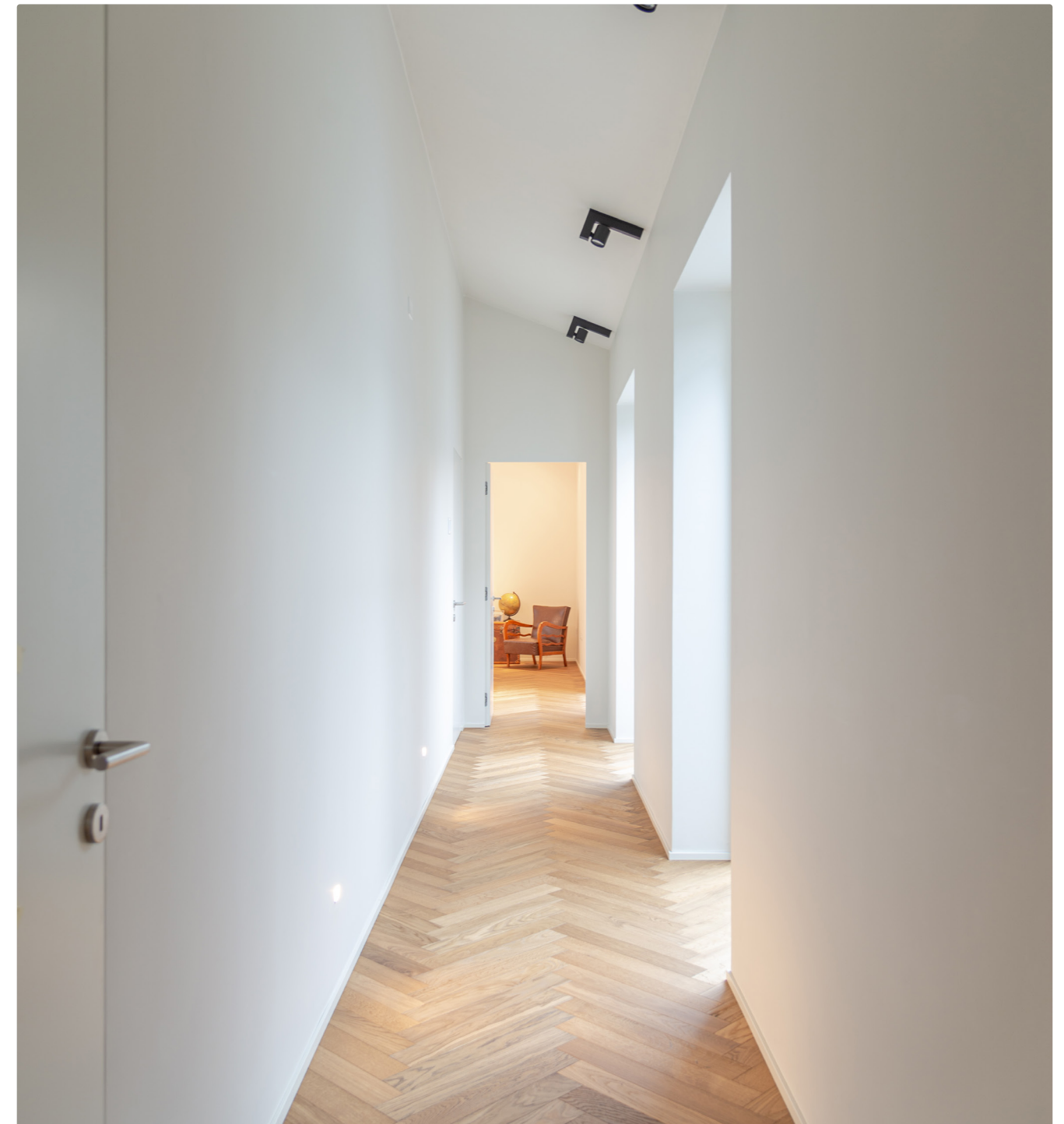

Ordering Codes

KR_____	___-	___
basic code	CCT-CRI	optic
KR921632 - erubo, black KR921635 - erubo, white	9027 9030 9040 9527 9530 9540	FL - flood 24° WFL - flood 38° VD - 1-10V DD - DALI PD - phase dim
Ordering example: KR921632-9027-FL-VD		





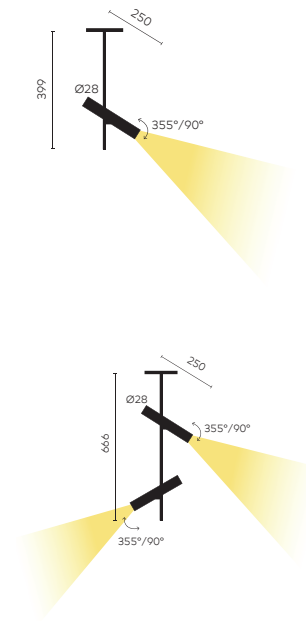

general information

application	surface-mounted luminaire for ceilings
IP classification	40
input voltage	230V
electric gear	see Required Accessory
louvre	always black for DL/WDL
illuminant (per lamphead)	
output DL-WDL	368lm
wattage SP	8W

Ordering Codes

KR_____	___-	___-	___
basic code	CCT-CRI	optic	dim protocol
KR963011 - esprit single, white KR963012 - esprit single, black KR963021 - esprit double, white KR963022 - esprit double, black	9027 9030	DL - dark light 33° WDL - wide dark light 56°	P1 - white (only available with white esprit) P2 - black (only available with black esprit)  A4 - brushed bronze A7 - brushed nickle A8 - brushed gold A9 - gun black
Ordering example: KR963011-9027-SP-P1			

Required Accessory (see page 60-61 for details)

KR_____	___
basic code	dim protocol
KR763591 - ceiling rose, esprit single, white, Ø85 x H155 KR763592 - ceiling rose, esprit single, black, Ø85 x H155 KR763791 - ceiling rose, esprit double, white, Ø85 x H155 KR763792 - ceiling rose, esprit double, black, Ø85 x H155	PD - phase dim DD - dali dim
Ordering example: KR963591-PD	

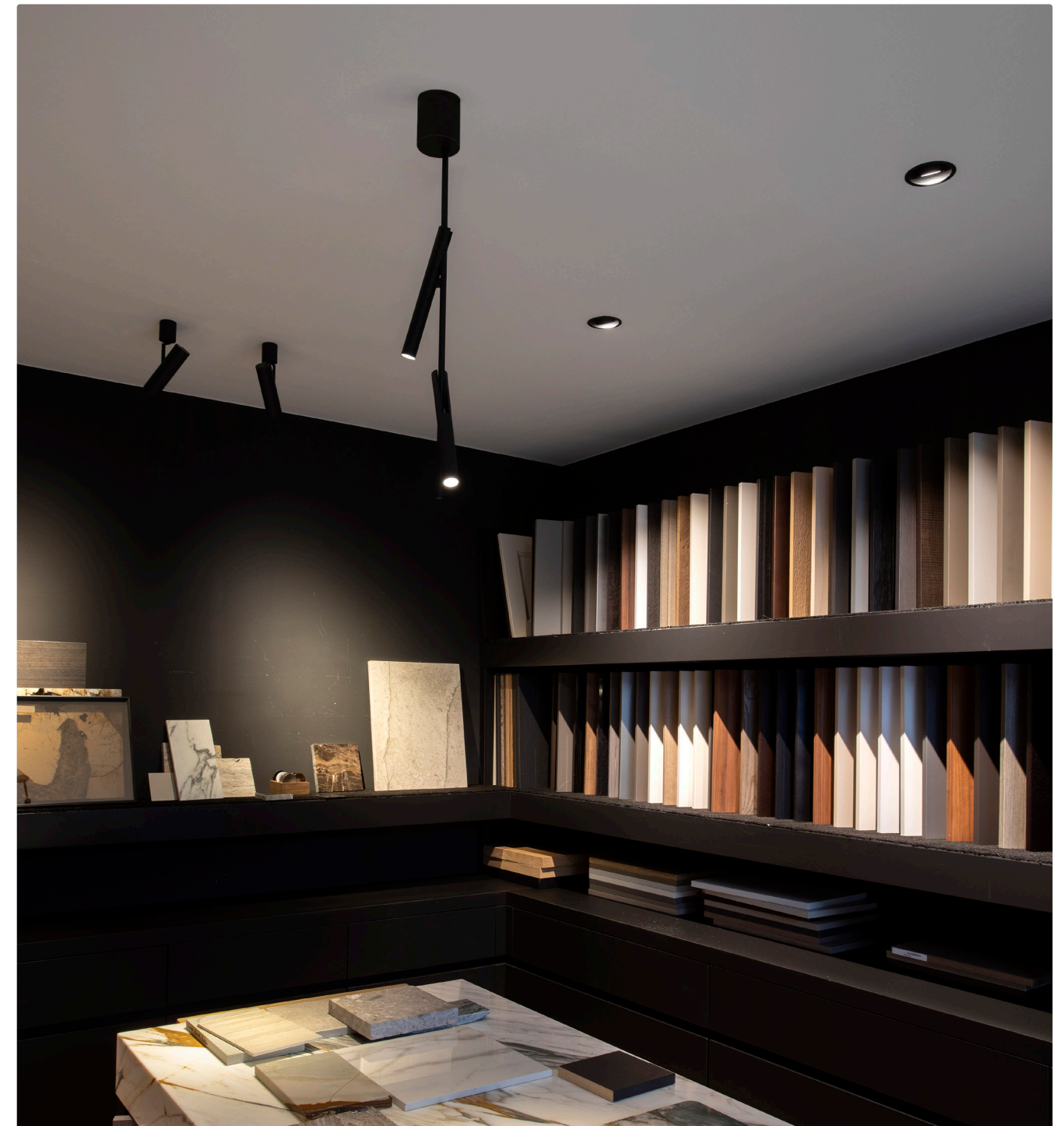



kreon fuga comes in 2 dimensions: 900 and 1200. By combining the head, the pendant bar and the ceiling bar, different combinations can be configured. The lower horizontal bar includes a CRI85, 2700K or 3000K LED-strip with diffuser for homogenous light output. This bar can be repositioned to an offset position or in the middle of the vertical bar. The additional possibility to rotate the lower horizontal bar by 90° makes kreon fuga a dynamic pendant luminaire.

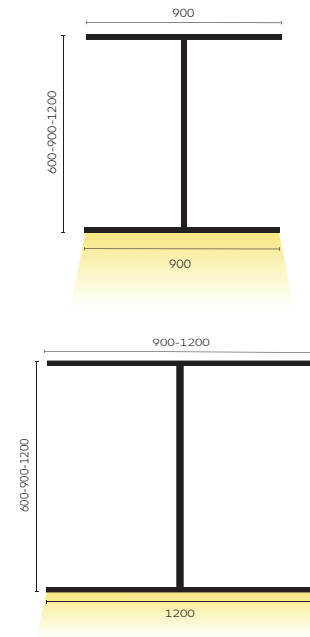

general information		
application	surface-mounted luminaire for ceilings	
IP classification	40	
input voltage	230V	
illuminant (per lamphead)		
output fuga 900	447lm	
output fuga 1200	578lm	



## Ordering Codes

KR____-	__-	__-	__-	__
basic code	CCT-CRI	dim protocol	pendant	base
KR974262 - fuga 900, black KR974362 - fuga 1200, black	8527 8530	SW - on off	06 - 600mm pendant 09 - 900mm pendant 12 - 1200mm pendant	09 - 600mm pendant 12 - 900mm pendant (only available for fuga 1200)
Ordering example: KR974262-8527-SW-06-09				

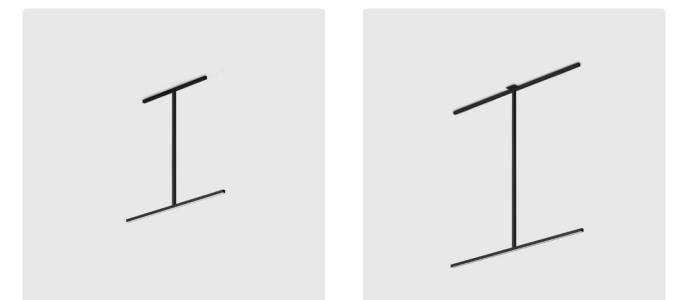



# kreon cadre linear

kreon cadre is a linear pendant luminaire characterised by its bold symmetric architectural form that can both frame space and interrupt it. Light is provided by multiple point LED sources providing an optimised solution for applications ranging from desk to dining table.

kreon cadre is available with solid telescopic side supports covered with the finest black grain leather and is finished with a black or chrome anodic layer.

general information	
application	surface-mounted spotlight
IP classification	40
input voltage	230V
electric gear	included
protection class	1
illuminant	
output cadre 1200	2670lm
output cadre 1500	3011lm

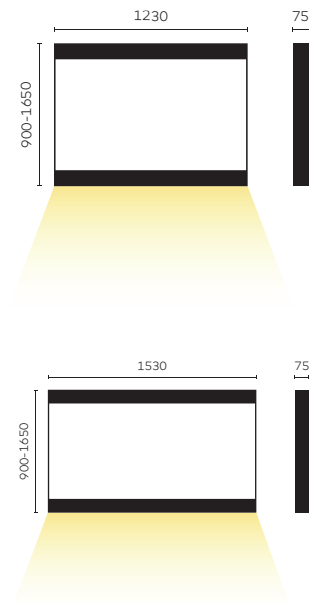

Project Showroom Iconno  
Location Madrid, Spain

Architect Iconno  
Photographer Iconno



## Ordering Codes

KR_____	___-	__-	-	-
basic code	CCT-CRI	dim protocol	suspension length	suspension color
KR963582 - cadre 1200 linear, black	9027	VD - 1-10V	S - 900 1200	1 - white
KR963584 - cadre 1200 linear, chrome	9030	DD - dali dim	H - 1200 1650	2 - black
KR963592 - cadre 1500 linear, black				
KR963594 - cadre 1500 linear, chrome				
Ordering example: KR963582-9027-VD-S-1				

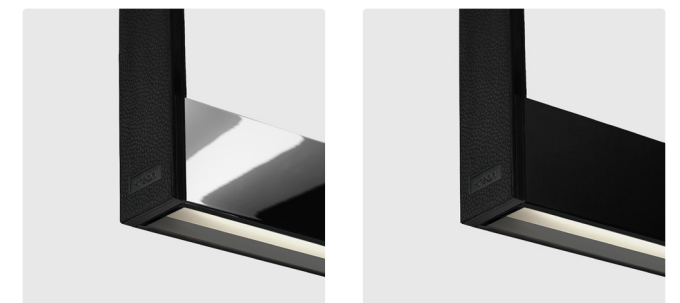



# kreon cadre spot

Project private residence  
Location Paris, France

Photographer Serge Brison

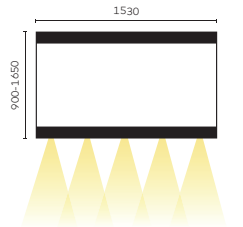
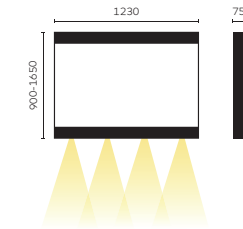

general information		
application	surface-mounted spotlight	
IP classification	40	
input voltage	230V	
electric gear	included	
protection class	1	
illuminant		
output cadre 1200	1294lm	
output cadre 1500	1505lm	

## Ordering Codes

KR_____	__	__	__
basic code	dim protocol	suspension length	suspension color
KR963582 - cadre 1200 spot, black (4 lamps)	VD - 1-10V	S - 900 1200	1 - white
KR963584 - cadre 1200 spot, chrome (4 lamps)	DD - dali dim	H - 1200 1650	2 - black
KR963592 - cadre 1500 spot, black (5 lamps)			
KR963594 - cadre 1500 spot, chrome (5 lamps)			
Ordering example: KR963582 + Required Accessory			

## Required Accessory

KR_____
basic code
KR763591 - Constant current MR16 LED lamp, 2700K, 36°
KR763592 - Constant current MR16 LED lamp, 3000K, 36°
Ordering example: KR763591





kreon holon 40 pendant is a suspended luminaire that is part of the kreon holon family. It offers various installation options, allowing it to be directly mounted on the ceiling, recessed, attached to a connection box or a 48V magnetic track. kreon holon 40 pendant can be customized with a spot, flood, or wide flood reflector, providing versatile lighting solutions for different applications

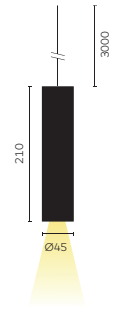

general information	
application	surface-mounted luminaire for ceilings
IP classification	40
input voltage	230V
electric gear	see Required Accessory
louvre	always black for DL/WDL
illuminant (per lamphead)	
output SP-FL-WFL	558lm
output DL-WDL	417lm
wattage	8,4W

#### Ordering Codes

KR____-	__-	__-	__
basic code	CCT-CRI	optic	louvre color
KR962001 - holon 40 pendant, white KR962002 - holon 40 pendant, black	9027 9030	SP - spot 20° FL - flood 35° WFL - wide flood 55° DL - dark light 38° WDL - wide dark light 76°	P1 - white P2 - black A5 - red copper
Ordering example: KR962001-9027-SP-P1			

#### Required Accessory (see page 60-61 for details)

KR____-	__
basic code	dim protocol
KR791431 - ceiling rose, single, white, Ø120 x H30 KR791432 - ceiling rose, single, black, Ø120 x H30 KR791201 - ceiling rose, double, white, L500 x W50 x H30 KR791202 - ceiling rose, double, black, L500 x W50 x H30	PD - phase dim DD - dali dim CD - casambi (not for single rose)
Ordering example: KR791431-PD	



kreon holon 60 pendant is a suspended luminaire that is part of the kreon holon family. kreon holon 60 pendant can be customized with a spot, flood, or wide flood reflector, providing versatile lighting solutions for different applications. Additionally, kreon holon 60 pendant is available with a satinated glass ring at the end. This ring will cast a soft ambient glow of light, visualizing the light within.

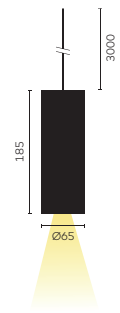

## general information

application	surface-mounted luminaire for ceilings
IP classification	40
input voltage	230V
electric gear	see Required Accessory

## illuminant

output CRI 90+	up to 1211lm
output CRI 95	up to 1090lm
wattage	10,2W/11,9W

## Ordering Codes

KR_____	___-	___-	___
basic code	CCT-CRI	optic	dim protocol
KR962851 - holon 60 pendant, white KR962852 - holon 60 pendant, black	9027 9030	SP - spot 20° FL - flood 35° WFL - wide flood 55° DL - dark light 38°	SW- on off DD - dali dim
Ordering example: KR962001-9027-SP-P1			

## Required Accessory (see page 60-61 for details)

KR_____
basic code
KR791411-HV - ceiling rose, single, white, Ø120 x H30 KR791412-HV - ceiling rose, single, black, Ø120 x H30
Ordering example: KR791411-HV





The range of kreon stone collection is characterized by a glow of light that creates a pleasant atmosphere through the translucent mineral material. In addition, the pendant luminaires have a diffused downward beam providing additional light on horizontal surfaces.

general information	
application	surface-mounted luminaire for walls
IP classification	40
input voltage	230V
electric gear	see Required Accessory
illuminant	
output	315lm
wattage	6,7W

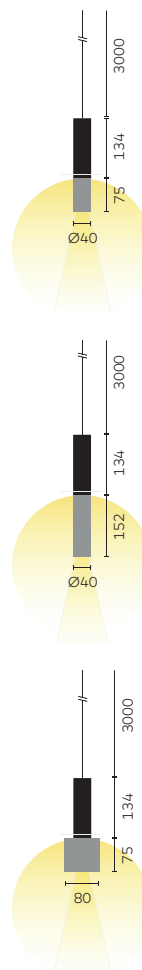

#### Ordering Codes

KR____-	—
basic code	CCT-CRI
KR991311 - oran stone, pendant, small cylinder, white	9027
KR991312 - oran stone, pendant, small cylinder, black	9030
KR991411 - oran stone, pendant, long cylinder, white	
KR991412 - oran stone, pendant, long cylinder, black	
KR991111 - oran stone, pendant, large cylinder, white	
KR991112 - oran stone, pendant, large cylinder, black	
KR991211 - oran stone, pendant, large cube, white	
KR991212 - oran stone, pendant, large cube, black	

Ordering example: KR991311-9027

#### Required Accessory (see page 60-61 for details)

KR____-	—
basic code	dim protocol
KR791431 - ceiling rose, single, white, Ø120 x H30	PD - phase dim
KR791432 - ceiling rose, single, black, Ø120 x H30	DD - dali dim (only double rose)
KR791201 - ceiling rose, double, white, L500 x W50 x H30	CD - casambi dim (only for double rose)
KR791202 - ceiling rose, double, black, L500 x W50 x H30	

Ordering example: KR791431-PD

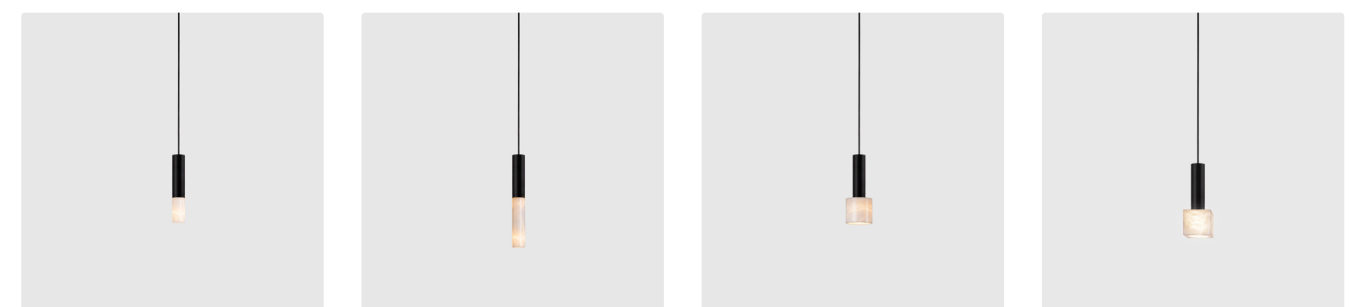

The range of kreon stone collection is characterized by a glow of light that creates a pleasant atmosphere through the translucent mineral material. In addition, the pendant luminaires have a diffused downward beam providing additional light on horizontal surfaces.

general information		
application	surface-mounted luminaire for walls	
IP classification	40	
input voltage	230V	
electric gear	see Required Accessory	
illuminant		
output	315lm	
wattage	6,7W	

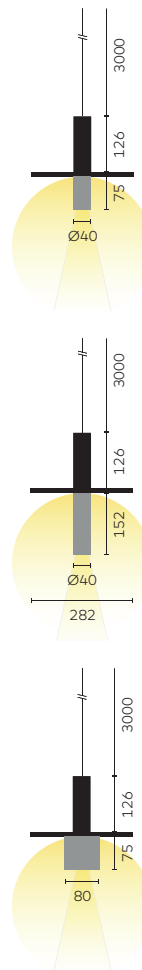

#### Ordering Codes

KR_____	—	
basic code	CCT-CRI	kap finish
KR991331 - oran stone kap, pendant, small cylinder, white	9027	P1 - white/white P2 - black/black A3 - black/grey A4 - black/bronze
KR991332 - oran stone kap, pendant, small cylinder, black		
KR991431 - oran stone kap, pendant, long cylinder, white		
KR991432 - oran stone kap, pendant, long cylinder, black		
KR991131 - oran stone kap, pendant, large cylinder, white		
KR991132 - oran stone kap, pendant, large cylinder, black		
KR991231 - oran stone kap, pendant, long cube, white		
KR991232 - oran stone kap, pendant, long cube, black		

Ordering example: KR991331-9027-P1

#### Required Accessory (see page 60-61 for details)

KR_____	—
basic code	dim protocol
KR791431 - ceiling rose, single, white, Ø120 x H30	PD - phase dim DD - dali dim (only for double rose) CD - casambi dim (only for double rose)
KR791432 - ceiling rose, single, black, Ø120 x H30	
KR791201 - ceiling rose, double, white, L500 x W50 x H30	
KR791202 - ceiling rose, double, black, L500 x W50 x H30	

Ordering example: KR791431-PD





# kreon esprit pendant

Project Agence Immobilière  
Daniel Féau  
Location Paris, France

Architect LD Studio Design  
Photographer Serge Brison

kreon esprit pendant are 3 or 4 individual lampheads mounted on a slender horizontal bar with steel tension cable suspension for maximum flexibility. It can be installed as an individual element or in a cluster of two or more.

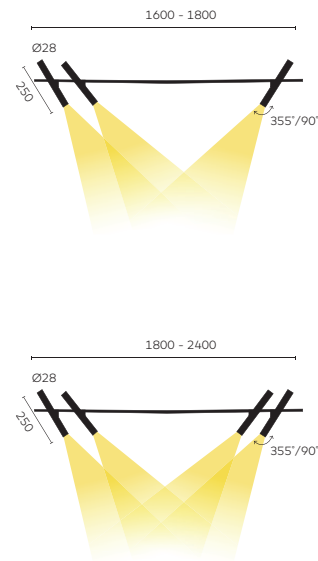

## general information

application	surface-mounted luminaire for ceilings
IP classification	40
input voltage	230V
electric gear	see Required Accessory
louvre	always black for DL/WDL

## illuminant (per lamphead)

output SP-FL-WFL	558lm
output DL-WDL	417lm
wattage SP	8,4W

## Ordering Codes

KR____-	__-	__-	__
basic code	CCT-CRI	optic	dim protocol
KR963732 - esprit triple, black, L=1600 KR963832 - esprit triple, black, L=1800 KR963842 - esprit quadruple, black, L=1800 KR963942 - esprit quadruple, black, L=2400	9027 9030	DL - dark light 33° WDL - wide dark light 56°	P1 - white (only available with white esprit) P2 - black (only available with black esprit)  A4 - brushed bronze A7 - brushed nickel A8 - brushed gold A9 - gun black
Ordering example: KR963011-9027-SP-P1			

## Required Accessory (see page 60-61 for details)

KR____-	__
basic code	dim protocol
KR763791 - ceiling rose, esprit double, white, Ø85 x H155 KR763792 - ceiling rose, esprit double, black, Ø85 x H155	PD - phase dim DD - dali dim
Ordering example: KR763791-PD	

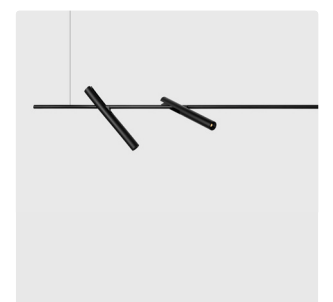

**Remark:**  
The horizontal suspension may slightly bend

The simple and archetypical volume of kreon onn-wall creates an indirect ambient lighting making it an ideal fixture for highlighting all types of ceilings. kreon onn-wall 165 and 300 benefit from the photometric advantages of the latest lens technology, in combination with high performing LED and creates a evenly spread indirect light distribution

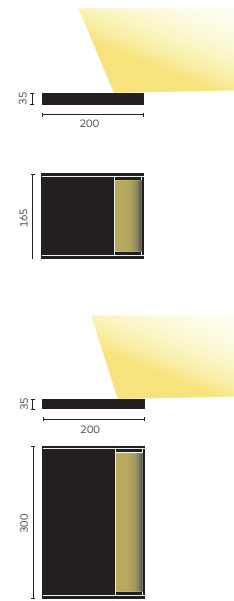

general information		
application	surface-mounted luminaire for walls	
IP classification	40	
input voltage	230V	
electric gear	included	
illuminant (per lamphead)		
output onn-wall 165	1590lm	
output onn-wall 300	3180lm	



### Ordering Codes

KR_____	___-	__
basic code	CCT-CRI	dim protocol
KR983411 - onn-wall 165, wide beam, white KR983412 - onn-wall 165, wide beam, black KR983421 - onn-wall 300, wide beam, white KR983422 - onn-wall 300, wide beam, black	9027	VD - 1-10V DD - dali dim
Ordering example: KR983411-9027-VD		

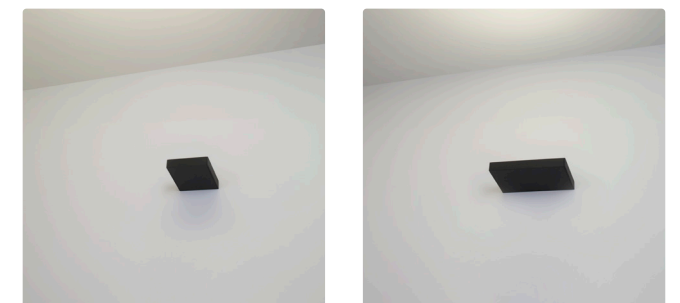



# kreon oran wall stone

kreon oran wall stone is a genuinely unique orientation light finished with alabaster. The alabaster diffuses light softly and evenly with a distinct translucency.

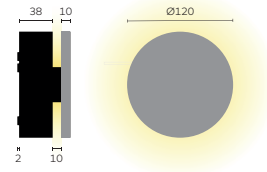

## general information

<b>application</b>	surface-mounted luminaire for walls
<b>IP classification</b>	20
<b>input voltage</b>	230V
<b>electric gear</b>	included

## illuminant

<b>output</b>	68lm
---------------	------

## Ordering Codes

KR_____	_____
basic code	CCT-CRI
KR991251 - oran wall stone, white	9027 9027
Ordering example: KR991251-9027	

Project private residence  
Location Casablanca, Morocco



# kreon kagi gearbox

kreon kagi + gearbox are surface mounted luminaires with a linear light and integrated gear, suitable for wall or ceiling application. The linear component is available in 3 different exexutions: diam. 16 or 26 and a version with a blinded surface. Available in 3 different lengths on a black or white 230V gearbox.

general information		
application	surface-mounted luminaire	
IP classification	40	
input voltage	230V	
electric gear	included	
illuminant		
output	873lm/m	

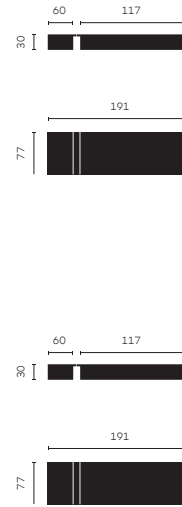

## Ordering Codes

KR____-	___-	___-	___
basic code	CCT-CRI	dim protocol	luminaire size
KR954511 - kagi 16, white gearbox	9027	SW - on off	XS - 532mm
KR964512 - kagi 16, black gearbox	9030	DD - dali dim	S - 1032mm
KR964611 - kagi 26, white gearbox			M - 1532mm
KR964612 - kagi 26, black gearbox			
KR964711 - kagi 26 SBU, white gearbox			
KR964712 - kagi 26 SBU, black gearbox			
Ordering example: KR964121-9027-SW-XS			





# kreon esprit floor round base

The design update of kreon esprit floor comes with a round base, which doubles as a cable depot, and a push-dim button on top of the vertical rod. In this way, ease of use and design are perfectly combined. The two lamp heads can be positioned individually to aim the light beam wherever you require: highlighting a work of art in your interior with the top light, while providing light at table level with the lower one.

## general information

IP classification	40
input voltage	230V
electric gear	included
power cable	supplied with 2,5 black braided cable
plug	EUR and UK plug included

## illuminant (per lamphead)

output SP	162lm
output DL-WDL	370lm

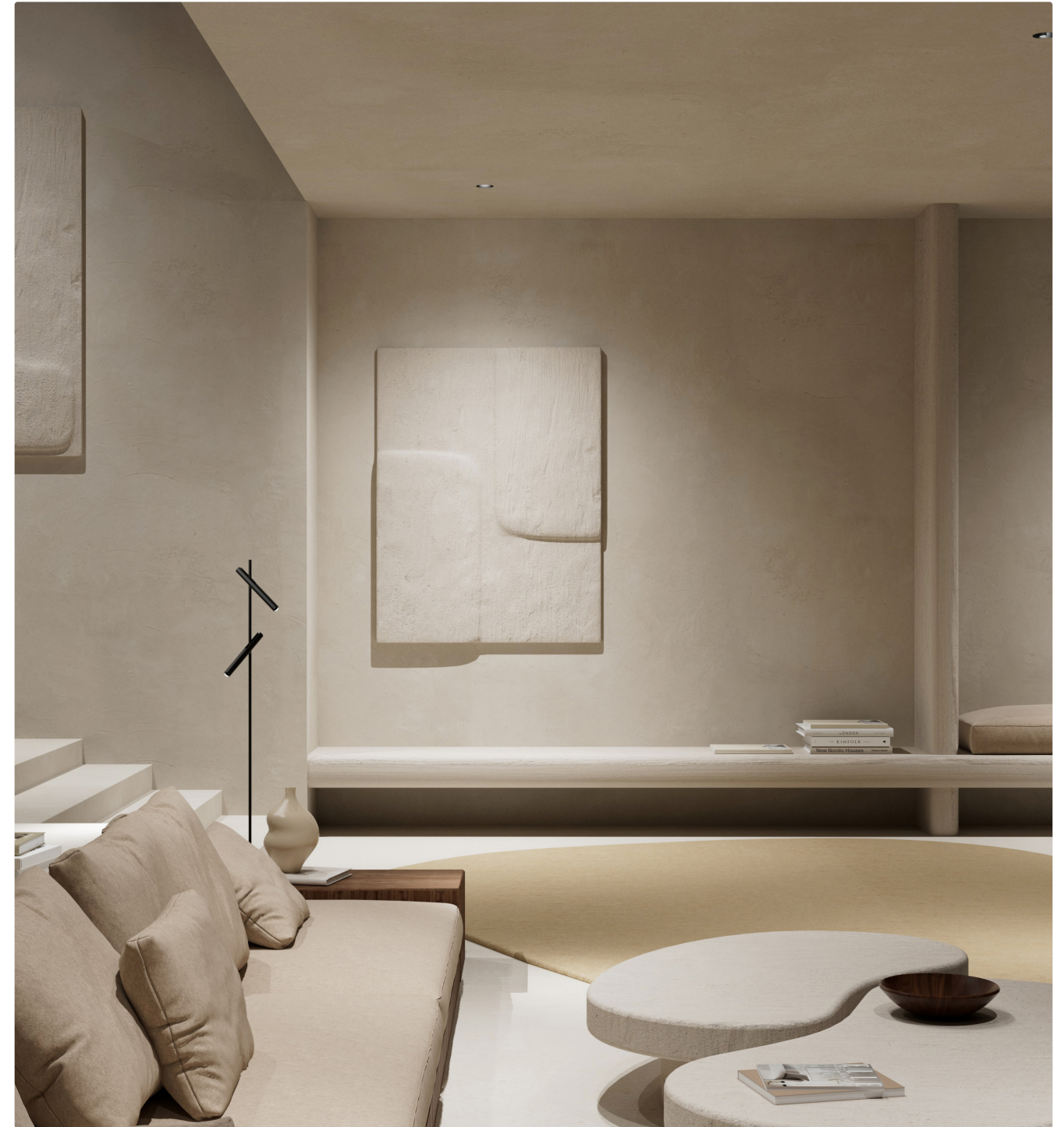
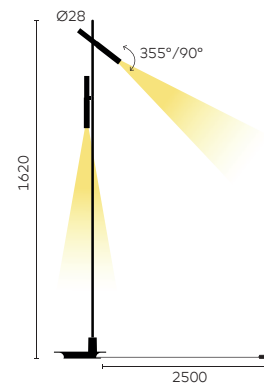
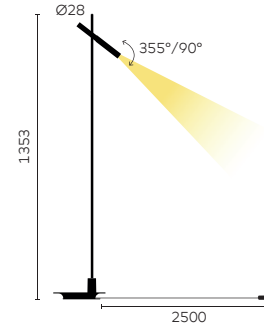

## Ordering Codes

KR_____	___-	___-	___
basic code	CCT-CRI	optic	lamphead colour
KR963411 - single floor, round base, white	9027	SP - spot 20°	P1 - white painted (only available with white esprit)
KR963412 - single floor, round base, black	9030	DL - dark light 33°	P2 - black painted (only available with black esprit)
KR963421 - double floor, round base, white		WDL - wide dark light 56°	A4 - bronze platina
KR963422 - double floor, round base, black			A7 - nickel plated
			A8 - brushed gold
			A9 - Gun black

Ordering example: KR963411-9027-SP-A4



kreon esprit desk is the product range's little brother. Although small in size, kreon esprit desk harnesses the same performant luminaire head of its larger counterparts. The lamp head can be positioned to fulfill your needs. At full brightness as a desk light during a hard day's work, or dimmed using the built-in touchdim button for some bedtime reading.

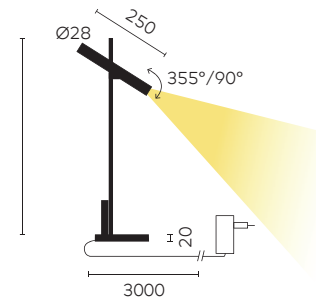

general information		
IP classification		40
input voltage		230V
electric gear		included
power cable		supplied with 2,5 black braided cable
plug		EUR and UK plug included
illuminant		
output		368lm



## Ordering Codes

KR_____	___-	___-	___
basic code	CCT-CRI	optic	lamphead colour
KR963911 - esprit desk, white KR963912 - esprit desk, black	9027	WDL- wide dark light 33°	P1 - white painted (only available with white esprit) P2 - black painted (only available with black esprit) A4 - bronze platina A7 - nickel plated A8 - brushed gold A9 - Gun black
Ordering example: KR963911-9027-WDL-A4			

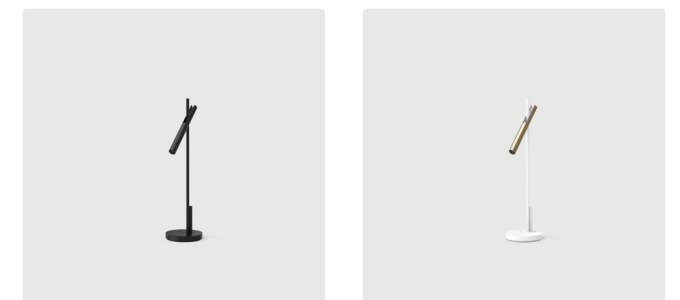



# kreon oran object

kreon oran object is a unique decorative desk luminaire finished with alabaster or handcrafted glass. The alabaster diffuses light softly and evenly with a distinct translucency.

general information		
application	desk luminaire	
IP classification	40	
input voltage	230V	
electric gear	ON-OFF, included	
illuminant (per lamphead)		
output oran object craft	290lm	
output oran object stone	43lm	

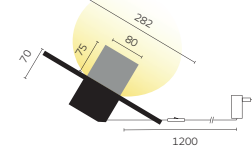
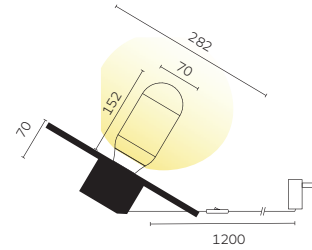
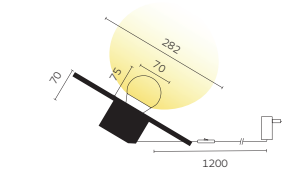

## Ordering Codes

KR_____	___-	__-	__
basic code	CCT-CRI	glass bulb shape	shade colour
KR991031 - oran object stone, white KR991032 - oran object stone, black KR991341 - oran object craft, white KR991342 - oran object craft, black	9027 9030	S - sphere bulb (only for oran object craft)  L - long ampoule (only for oran object craft)	P1 - white shade bottom (only for oran object white)  P2 - black shade bottom (only for oran object black)  A3 - grey shade bottom (only for oran object black)  A4 - bronze shade bottom (only for oran object black)
Ordering example: KR991031-9027-S-P1			





kreon wabi is an IP65 external spotlight. This compact luminaire is available with a LED lightsource, a 30° beamangle and a colour temperature of either 2700K or 3000K. kreon wabi is a screwbased spotlight.

The luminaire head can be rotated 360° and tilted up to 90°. The inclination of the luminaire is lockable and can easily be set by using the marks indicated on the fixture.

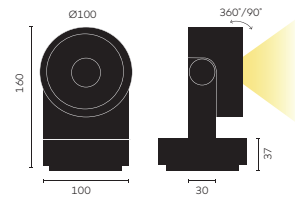

general information		
application	surface-mounted luminaire for outdoor	
IP classification	65	
input voltage	230V	
electric gear	included	
protection class	2	
illuminant		
output	133lm	
beam angle	30°	



Ordering Codes

KR_____	_____	___
basic code	CCT-CRI	optic
KR943052 - wabi, black	9027 9030	FL - flood 30°
Ordering example: KR943052-9027-FL		

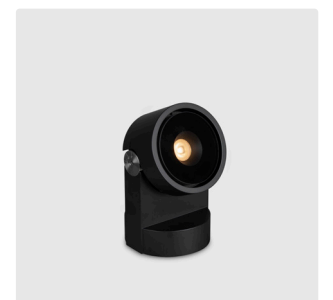

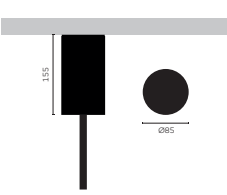

# kreon gearbox overview

	<b>esprit single ceiling</b>	<b>p27</b>
reference	<b>KR763591 - PD</b> <b>KR763592 - PD</b> <b>KR763591 - DD</b> <b>KR763592 - DD</b>	ceiling rose, white, phase dim ceiling rose, black, phase dim ceiling rose, white, dali dim ceiling rose, black, dali dim
dimensions	<b>Ø85 x H155</b>	

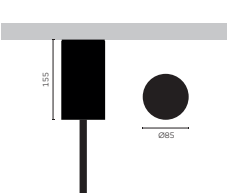
	<b>esprit double ceiling</b>	<b>p27</b>
reference	<b>KR763791 - PD</b> <b>KR763791 - DD</b> <b>KR763792 - PD</b> <b>KR763792 - DD</b>	ceiling rose, white, phase dim ceiling rose, white, dali dim ceiling rose, black, phase dim ceiling rose, black, dali dim
dimensions	<b>Ø85 x H155</b>	

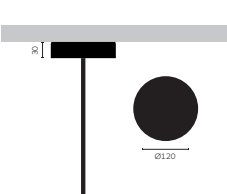
	<b>holon 40 single pendant</b>	<b>p35</b>
reference	<b>KR791431 - PD</b> <b>KR791431 - DD</b> <b>KR791432 - PD</b> <b>KR791432 - DD</b> <b>KR791411 - HV</b> <b>KR791412 - HV</b>	ceiling rose, white, phase dim ceiling rose, white, dali dim ceiling rose, black, dali dim ceiling rose, black, dali dim ceiling rose, black, dali dim ceiling rose, black, dali dim
dimensions	<b>Ø120 x H30</b>	

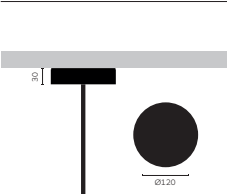
	<b>holon 60 single pendant</b>	<b>p37</b>
reference	<b>KR91411 - HV</b> <b>KR791412 - HV</b>	ceiling rose, white ceiling rose, black
dimensions	<b>Ø120 x H30</b>	

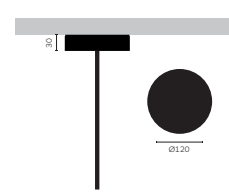
	<b>oran stone oran stone kap single pendant</b>	<b>p39</b>
reference	<b>KR791431 - PD</b> <b>KR791432 - PD</b>	ceiling rose, white, phase dim ceiling rose, white, phase dim
dimensions	<b>Ø120 x H30</b>	

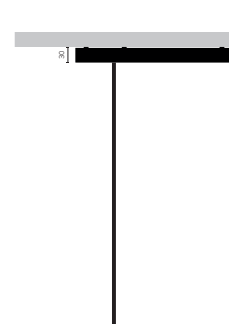
	<b>oran stone oran stone kap double pendant</b>	<b>p41</b>
reference	<b>KR791201 - PD</b> <b>KR791201 - DD</b> <b>KR791201 - CD</b> ‡ <b>KR791202 - PD</b> <b>KR791202 - DD</b> <b>KR791202 - CD</b> ‡	ceiling rose, white, phase dim ceiling rose, white, dali dim ceiling rose, white, casambi dim ceiling rose, black, phase dim ceiling rose, black, dali dim ceiling rose, black, casambi dim
dimensions	<b>L500 x W50 x H30</b>	

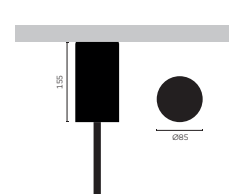
	<b>esprit pendant</b>	<b>p43</b>
reference	<b>KR763791 - PD</b> <b>KR763791 - DD</b> <b>KR763792 - PD</b> <b>KR763792 - DD</b>	ceiling rose, white, phase dim ceiling rose, white, dali dim ceiling rose, black, phase dim ceiling rose, black, dali dim
dimensions	<b>Ø85 x H155</b>	

# kreon offices

## **kreon HQ**

Industrieweg Noord 1152  
3660 Oudsbergen  
Belgium  
T +32 89 81 97 80  
belgium@kreon.com

## **kreon Austria**

austria@kreon.com

## **kreon China**

Rm 208, Building 5, n°. 33  
Lane 672, Changle Road  
JingAn District, Shanghai  
P.R. China  
T +86 136 6161 9560  
china@kreon.com

## **kreon France**

5, rue d'Aboukir  
75002 Paris  
France  
T +33 1 44 50 53 54  
france@kreon.com

## **kreon Germany**

Brühler Straße 11-13  
50968 Cologne  
Germany  
Tel +49 221 937 22 0  
germany@kreon.com

## **kreon Italy**

Via V. Forcella 5  
20144 Milano  
Italy  
T +39 02 89 42 08 46  
italy@kreon.com

## **kreon Middle East**

Dubai Airport Free Zone Area  
(DAFZA)  
West Wing 6 (W6)  
Office 6 WA 420  
P.O. Box 293845  
Dubai  
United Arab Emirates  
T +971 4 6091 355  
middle.east@kreon.com

## **kreon inc.**

### **North America & Canada**

20 Murray Hill Parkway  
Suite 180  
East Rutherford, NJ 07073  
USA  
T +1 516 470 9522  
usa@kreon.com

## **kreon Poland**

T +48 504 788 355  
Poland  
poland@kreon.com

## **kreon South East Asia**

singapore@kreon.com

## **kreon Spain**

Ángel Guimera 7-9 local C  
Barcelona 08017  
Spain  
T +34 600 462 551  
spain@kreon.com

## **kreon Switzerland**

Neufeldweg 6  
5103 Möriken  
Switzerland  
T +41 61 316 74 01  
switzerland@kreon.com

## **kreon The Netherlands**

Danzigerbocht 39a  
1013 AM Amsterdam  
The Netherlands  
T +31 (0)2 02 153 333  
the.netherlands@kreon.com

## **kreon Turkey**

Sehit Murat Demirli Cad.  
Resadiye Yolu 76  
Alemdag-Ümraniye 34794  
Istanbul  
Turkey  
proje@kreon.com.tr  
T +90 216 430 86 00

## **kreon UK**

67 Maltings Place  
169 Tower Bridge Road  
London SE1 3LJ  
United Kingdom  
T +44 (0)20 7740 2112  
uk@kreon.com



